IMPORTANT INSTRUCTIONS
SAVE THESE INSTRUCTIONS

MODE D'EMPLOI IMPORTANT
CONSERVEZ LES PRESENTES INSTRUCTIONS

INSTRUCCIONES IMPORTANTES
GUARDE ESTAS INSTRUCCIONES

ISTRUZIONI IMPORTANTI
CONSERVARE LE ISTRUZIONI



COFFEE MAKER



CAFETERIE



CAFETERA



MACCHINA DA CAFFÈ

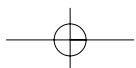
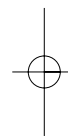
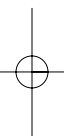
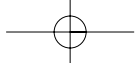

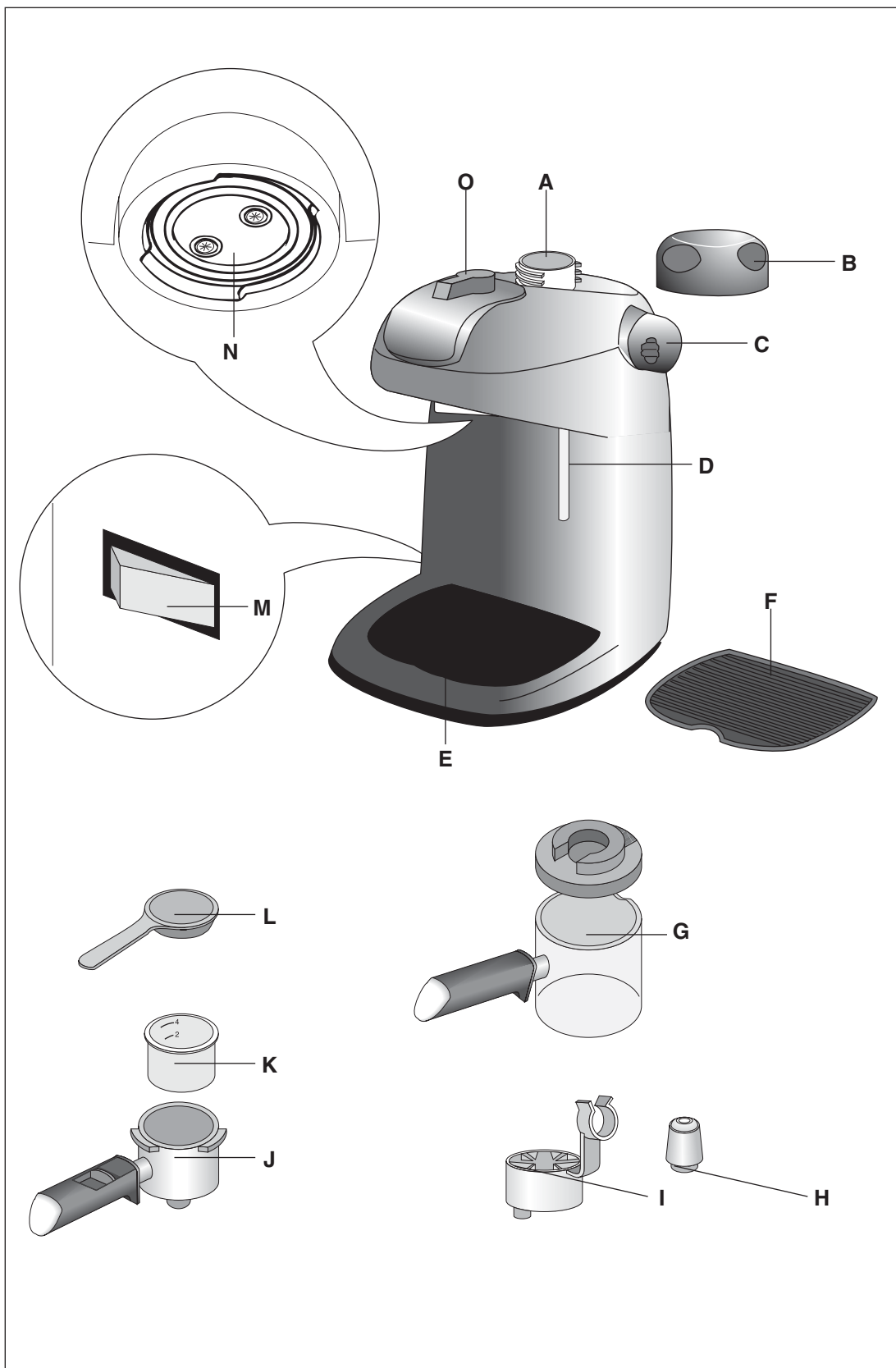

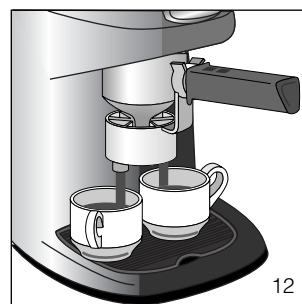
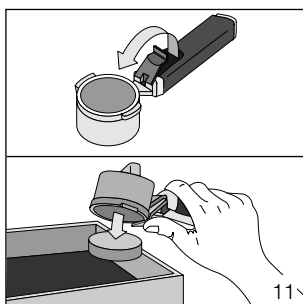
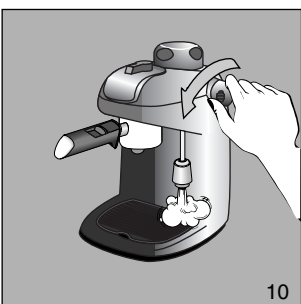
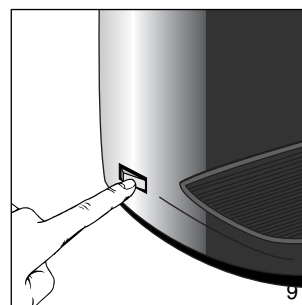
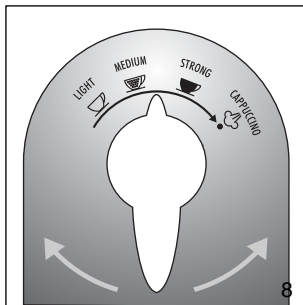
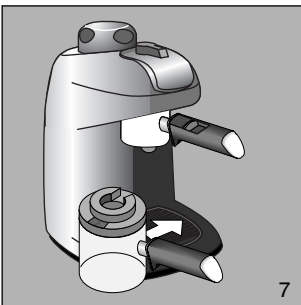
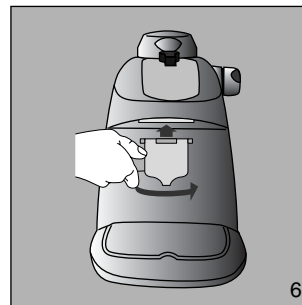
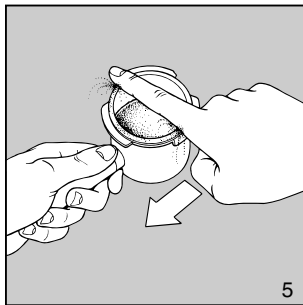
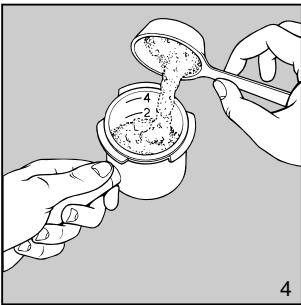
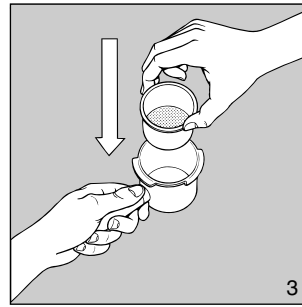
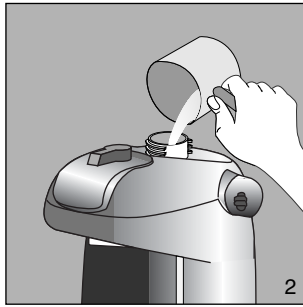
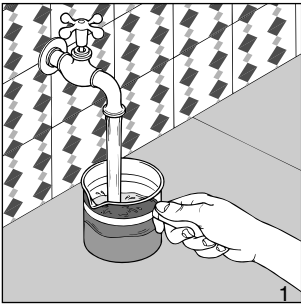

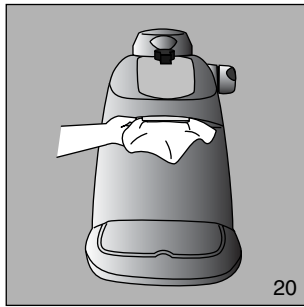
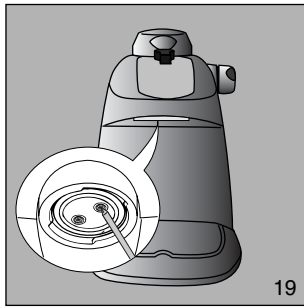
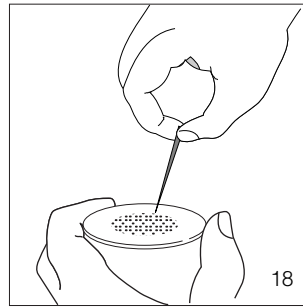
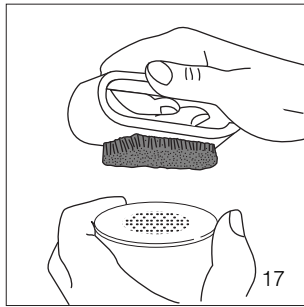
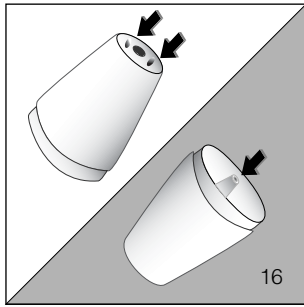
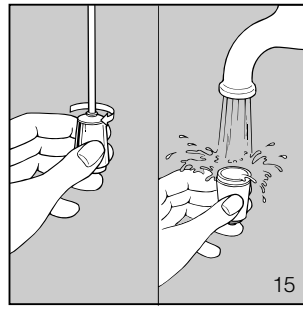
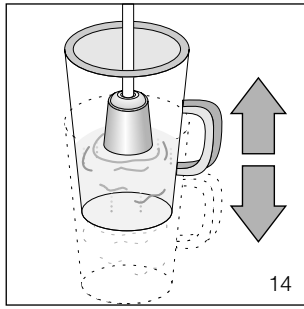
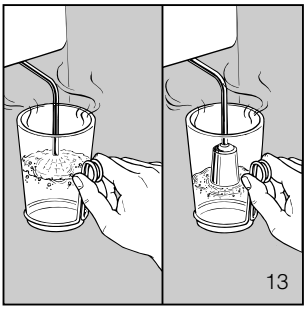

IMPORTANT SAFEGUARDS

When using electrical appliances, basic safety precautions should always be followed, including the following:

- Read all instructions.
- Do not touch hot surfaces. Use handles and knobs.
- To protect against fire, electrical shock and personal injury, do not immerse cord, plug or appliance in water or other liquid.
- Never allow the appliance to be used by children or unfit persons.
- Unplug from the outlet when not in use and before cleaning. Allow to cool before fitting or taking off parts, and before cleaning the appliance.
- Do not operate with a damaged cord or plug, or after the appliance malfunctions, or has been damaged in any manner. Return the appliance to the nearest authorized service facility for examination, repair or adjustment.
- The use of accessory attachments or spare parts not recommended by the appliance manufacturer may result in fire, electrical shock or personal injury.
- Do not use outdoors.
- Do not let the cord hang over the edge of the table or counter, or touch hot surfaces.
- Do not place on or near a hot gas or electrical burner, or in a heated oven.
- Plug cord into the wall outlet. To disconnect, turn any control to "off", then remove plug from wall outlet.
- Do not use the appliance for other than the intended use. This appliance is to be utilised for domestic use only. Any other use is to be considered improper and therefore, dangerous.
- DO NOT unscrew or remove boiler cap while the machine is in operation. Wait until brewing cycle is completed and all water and steam has been used up.

SAVE THESE INSTRUCTIONS

THIS PRODUCT IS FOR HOUSEHOLD USE ONLY

SHORT CORD INSTRUCTIONS

- A short power cord is provided to reduce risks resulting from becoming entangled in or tripping over a longer cord.
- Longer, detachable power supply cords or extension cords are available and may be used if care is exercised in their use.
- If an extension cord is used, the marked electrical rating should be at least as great as the electrical rating of the appliance. If the appliance is provided with 3-wire, grounding type cord, the extension should be a GROUNDING TYPE 3 - WIRE CORD. The longer cord should be arranged so that it will not drape over the counter-top or table top where it can be pulled on by children or tripped over.
- Your product is equipped with a polarized alternating current line plug (a plug having one blade wider than the other). This plug will fit into the power outlet only one way. This is a safety feature. If you are unable to insert the plug fully into the outlet, try reversing the plug. If the plug should still fail to fit, contact your electrician to replace your obsolete outlet. Do not defeat the safety purpose of the polarized plug.

Please read this instruction booklet carefully before installing the appliance and keep it handy for future consultation. In so doing you will obtain the best result and maximum safety in its use.

DESCRIPTION OF THE APPLIANCE

The following terms are used throughout the instruction manual:

- A. Water tank
- B. Cap with safety valve
- C. Steam knob
- D. Steam tube
- E. Drip tray
- F. Cup tray
- G. Carafe with lid
- H. Cappuccino nozzle
- I. Cup adapter (if included)
- J. Filter holder
- K. Filter
- L. Measuring spoon
- M. ON/OFF Switch
- N. Boiler outlet
- O. Vario system (if included)

SAFETY WARNINGS

- This machine has been built to "make coffee" and to "reheat beverages"; please be careful to avoid burns from the sprays of hot water or steam and avoid any improper use.
- When the appliance is in use, do not touch any of the machine's hot surfaces.
- After unpacking, make sure that the machine is complete and undamaged. In case of doubt, do not use the appliance and seek the advice of a qualified De'Longhi service professional.
- Packaging materials (plastic bags, foam polystyrene, etc.) should not be left within the reach of children as this could be a potential source of danger.
- This appliance is to be utilized for domestic use only. Any other use is to be considered improper and therefore, dangerous.
- The manufacturer takes no responsibility for damage derived from improper use.
- Never touch the appliance with wet or damp hands.
- The appliance is not intended for use by children without supervision.
- Children should be supervised to ensure that they do not play with the appliance.
- In case of breakdown or malfunctioning, turn off the appliance immediately and do not touch it. For repairs, please contact an authorized De'Longhi Service Center and request the use of original replacement parts only. The lack of respect for this point may compromise the safe use of the appliance.
- The power supply cable of this appliance must never be replaced by the user, because its replacement requires the use of special tools. If the cord should become damaged, or in case it needs to be replaced, please go to an authorized De'Longhi Service Center.
- When the appliance is not in use, turn off and disconnect the plug from the outlet.
- As with any electrical appliance, the instructions aim to cover as many eventualities as possible. Caution and common sense should be applied when operating your appliance, particularly in the vicinity of children.

INSTALLATION

- Place the coffee maker on flat work surface at a safe distance from taps and sinks.
- Check that the voltage corresponds to that indicated on the appliance rating plate. The appliance must always be connected to a well-grounded outlet rated at 10 A minimum. The manufacturer is not liable for damage caused by inadequate grounding of the appliance.
- In the event of incompatibility between the plug on the appliance and the outlet, have the plug replaced with another of the right type by a qualified De'Longhi professional. If the cord is damaged or requires replacing, contact an authorized De'Longhi Service Center.
- Never install the machine in an environment that can reach a temperature less than or equal to 0°C (32°F) (if the water in it freezes, the coffee maker may be damaged).
- In the event of breakdowns or malfunctioning, do not tamper with the appliance and switch it off by unplugging it.

HOW TO MAKE A PERFECT ESPRESSO

- 1 Unscrew the water tank cap by turning it counter-clockwise.
- 2 Using the carafe supplied (fig. 1) pour water into the boiler (fig. 2) according to the amounts shown in the table at the end of the text. **Do not exceed the amounts shown as this could cause the appliance to malfunction.** While filling the boiler make sure the ON/OFF switch is in the OFF position.
- 3 Carefully close the boiler cap by turning it clockwise.
- 4 Insert the filter into the filter-holder. (fig. 3).
- 5 Put the coffee evenly into the filter according to the amounts shown in the table following (fig. 4). It is important to use medium ground coffee. (Avoid using too finely ground coffee otherwise the filter could become blocked).
- 6 Remove excess coffee from the filter rim (fig. 5).
- 7 To attach the filter-holder to the machine place the filter holder under the heater-faucet (fig. 6). At this point press filter holder upwards while at the same time rotating counter-clockwise all the way. It is important that the filter holder be firmly set in its housing.
- 8 The carafe with the lid must be positioned under the filter holder so that the spout is inside the opening on the carafe's lid. Make sure that the steam knob is turned off.
9. If the machine includes the Vario System, position the lever within the desired area according to the type of coffee desired: "light", "medium" or "strong" (fig.8).
- 10 Press the ON/OFF switch (fig.9). The pilot light will illuminate.
- 11 About three minutes are required before the coffee begins to be discharged. Turn off power switch after coffee has been discharged.
- 12 **Before unscrewing the boiler cap or removing the filter holder, residual pressure must be released by slowly turning the steam knob (fig. 10) so that the residual steam can escape.**

Note: For safety reasons, it is not possible to open the boiler cap when the boiler is hot. If it has to be removed for any reason, it is always necessary to let off steam from the boiler using the steam knob as described immediately above.

- 13 To detach the filter holder, turn the handle from right to left.
To remove coffee grounds from the filter holder, turn upside down and knock it repeatedly until all grounds have been removed (fig. 11), or rinse the filter holder unit under running water and let drip dry.

NOTE: To eliminate the "new" smell, the first time you use the appliance, perform the coffee-making cycle a couple of times without drinking the coffee.

Coffee flows directly into the cups

The carafe can be used to brew 2 or 4 cups of coffee. If you prefer to brew 2 cups only, fit the adaptor to the lower section of the filter holder (fig. 12) and place the cups directly underneath the nozzles. In this way, the coffee will flow directly into the cups.

MAKING CAPPUCCINO

A cappuccino is an espresso coffee with a froth topping made by heating milk.

- 1 Using the following table as a guide, pour the required amount of milk into carafe. The best results will be achieved using whole milk, not skim, which should be at refrigerator temperature.
- 2 Transfer the milk into a container. The container should be large enough to allow the milk to expand to triple its volume.

Models with the Vario System

- 3 Follow steps 1-10 in the section "How to make Espresso Coffee".

Note that the amount of water needed to make 2 cups of cappuccino is greater than that required for 2 cups of normal coffee as it also necessary to produce the steam to emulsify the milk. You are recommended to position the flow regulator on "MEDIUM".

- 4 Allow the coffee to drip into the carafe until it reaches the number 2 marked on the side of the carafe, then select "CAPPUCCINO".

When the coffee starts to drip from the filter holder, place the steam nozzle in the milk ensuring that the nozzle opening is just under the surface of the milk, as shown in fig. 13 and open the steam valve by turning the steam knob counter-clockwise.

- 5 Move the container up and down under the steam nozzle as in fig. 14 (this will give maximum froth). **Froth the milk until the steam in the boiler has been completely used up**, then turn the steam knob in a clockwise direction in order to close the steam valve and set the ON/OFF switch to "OFF"

Warning: Always empty the boiler of any residual water or steam after using the appliance by turning on the steam knob.

- 6 Pour gently or preferably spoon the frothy milk onto the coffee, then sprinkle on a little chocolate powder for perfect cappuccino coffee.

Models without the Vario System

- 3 Follow steps 1-10 in the section "Making Espresso".

Note that the amount of water needed to make 2 cups of cappuccino is greater than that required for 2 cups of normal coffee as it also necessary to produce the steam to emulsify the milk.

- 4 When the coffee starts to drip from the filter holder, place the steam nozzle in the milk ensuring that the nozzle opening is just under the surface of the milk, as shown in fig. 13 and open the steam valve by turning the steam knob counter-clockwise.
5. Move the container up and down under the steam nozzle as in fig. 14 (this will give maximum froth). **Froth the milk until the steam in the boiler has been completely used up**, then turn the steam knob in a clockwise direction.
- 6 Allow the remaining coffee to drip through the filter holder into the carafe, it takes about 3 minutes, then switch the appliance OFF.
- Warning: Always empty the boiler of any residual water or steam after using the appliance by turning on the steam knob.**

- 7 Pour the coffee into cups, gently pour, or preferably spoon the frothy milk onto the coffee, then sprinkle on a little chocolate powder for perfect cappuccino coffee.

Cleaning the cappuccino nozzle

Clean the steam tube (with the cappuccino nozzle) of milk immediately after use, as dried milk can be difficult to remove.

Remember: You do this by turning the steam control knob counter-clockwise.

IMPORTANT: Always clean the milk frother and steam nozzle immediately after use. Proceed as follows:

- By turning the steam knob (fig. 15), allow a little steam to come out for a few seconds.
- Check that the 3 holes shown in fig. 16 are not blocked. If necessary, clean them with the help of a pin.
- Wash the cappuccino maker and steam nozzle thoroughly with warm water.
- Re-attach the cappuccino maker.

HINTS

Making good espresso and cappuccino is not difficult, however it does require practice. The following tips will help you get the best results from your machine:

- Warm the cups before filling with coffee.
- Use a dedicated espresso coffee for best results. They are now widely available from supermarkets.
- Freshly ground coffee provides the best flavor. To maintain flavor, fresh coffee is best stored in an airtight container in a cool place, even in the fridge.

CLEANING AND MAINTENANCE

1. Do not use solvents or detergents in cleaning the coffee maker. Use a soft, damp cloth.
2. Clean the filter-holder, filter and drip tray regularly.

ATTENTION: During cleaning, never immerse the unit in water – it is an electrical appliance.

CLEANING THE FILTER HOLDER

About every 300 coffees, clean the filter holder for ground coffee as follows:

- Remove the filter
- Clean the inside of the filter holder. Never wash in a dishwasher.
- Rinse all components and clean the metal filter thoroughly in hot water using a brush (fig. 17). Make sure the holes in the metal filter are not blocked. If necessary, clean with a pin (fig. 18).

Failure to clean as described above invalidates the warranty.

CLEANING THE ESPRESSO BOILER OUTLET

About every 300 coffees, the espresso boiler outlet must be cleaned as follows:

- check that the coffee machine is not warm and the plug is detached from the mains;
- using a screwdriver, unscrew the two screws that hold the outlet of the espresso boiler (fig. 19);
- clean the boiler with a damp cloth (fig. 20);
- clean the outlet thoroughly in hot water using a brush. Make sure the holes are not blocked. If necessary, clean with a pin.
- rinse the outlet under the tap, still scrubbing it;
- replace the outlet of the espresso boiler.







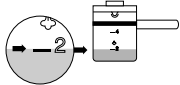

Failure to clean as described above invalidates the guarantee.

DESCALING

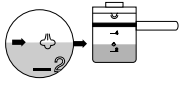
You are recommended to descale the coffee machine about every 300 coffees. You should use a commercially available product specifically for descaling espresso coffee machines. If you cannot obtain such a product, you can also follow the procedure below.

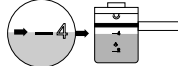
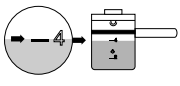
1. First clean the coffee machine, turn off and unplug from the outlet.

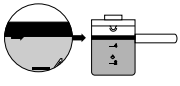
2. Fill the carafe to the brim.
3. Dissolve 1 spoonful (about 10/15 g) of citric acid;
4. Pour the solution into the boiler.
5. Replace the boiler cap and leave the solution to work for about 30 minutes.
6. Place the selector in the "LIGHT" position.
7. Put the filter and filter holder in position (without coffee).
8. Position the carafe on the drip tray.
9. Plug into the outlet.
10. Turn the coffee machine on. After a few minutes, the hot solution will start to flow through the filter holder into the carafe.
11. Place the steam tube in a glass or cup. Open the steam knob for a few seconds while the descaling solution flows through the filter holder. This cleans all residues of milk from inside the tube.
12. Close the steam knob (the descaling solution will continue to flow into the carafe).
13. When the solution stops flowing into the carafe, turn off and allow the machine to cool down. Remove the filter holder, filter and carafe and rinse with hot water.
14. To remove traces of descaler, perform at least 2 coffee-making cycles without coffee.

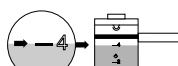
To make	Water quantity in the carafe	Coffee quantity in the filter	Milk quantity in the carafe
2 espressos			
2 cappuccinos	Water level must coincide with steam symbol on the carafe 		Use Max. 1 carafe filled to the level 4 
4 espressos			
4 cappuccinos	Water level must coincide with the bottom part of the metal band 		Use Max. 2 carafes filled to the level 4 



Limited Warranty

What Does This Warranty Cover? We warrant each Espresso Coffee Machine to be free from defects in material and workmanship. Our obligation under this warranty is limited to replacement or repair, free of charge at our factory or authorized service centers, of any defective part or parts thereof other than parts damaged in transit, which shall be returned to us, transportation prepaid. This warranty shall apply only if the Espresso Coffee Machine is used in accordance with the factory directions which accompany it.

How Long Does The Coverage Last? This warranty runs for one year from the date of delivery and applies only to the original purchaser.

What Does This Warranty Not Cover? This warranty does not cover defects or damage of the Espresso Coffee Machine which result from repairs or alterations to the machine outside our factory or authorized service centers, nor shall it apply to any Espresso Coffee Machine which has been subject to abuse, misuse, negligence or accidents. Also, consequential and incidental damages resulting from the use of this product or arising out of any breach of contract or breach of this warranty are not recoverable under this warranty. Some states do not allow the exclusion or limitation of incidental or consequential damages, so the above limitation may not apply to you.

How Do You Get Service? If repairs become necessary or spare parts are needed, please write to:

De'Longhi America Inc.

Park 80 West Plaza One, 4th floor
Saddle Brook NJ 07663
or call Service Tel. No 1-800-322-3848

or visit our internet site:
www.delonghiusa.com

De' Longhi CANADA

1040 Ronsa Court
MISSISSAUGA, ONTARIO
L4W 3Y4 CANADA

The above warranty is in lieu of all other express warranties and representations; All implied warranties are limited to the applicable warranty period set forth above. This limitation does apply if you enter into an extended warranty with De'Longhi. Some states do not allow limitations on how long an implied warranty lasts, so the above exclusions connection with the sale or use of its Espresso Coffee Machine.

How Does State Law Apply? This warranty gives you specific legal rights, and you may also have other rights which vary from state to state.