

Register your product and get support at  
[www.philips.com/welcome](http://www.philips.com/welcome)

02

English

# INTELIA

Type HD8753

USER MANUAL



EN

02

PLEASE READ THIS USER MANUAL CAREFULLY BEFORE USING THE MACHINE.

CE

 **Saeco**

# IMPORTANT SAFEGUARDS

When using electrical appliances, basic safety precautions should always be followed, including the following:

1. Read all instructions.
2. Do not touch hot surfaces. Use handles or knobs.
3. To protect against fire, electric shock and injury to persons do not immerse cord, plugs, or appliance in water or other liquid.
4. Close supervision is necessary when the appliance is used by or near children.
5. Unplug from outlet when not in use and before cleaning. Allow to cool before putting on or taking off parts, and before cleaning the appliance.
6. Do not operate any appliance with a damaged cord or plug or after the appliance malfunctions, or has been damaged in any manner. Return appliance to the nearest authorized service facility for examination, repair or adjustment.
7. The use of accessory attachments not recommended by the appliance manufacturer may result in fire, electric shock or injury to persons.
8. Do not use outdoors.
9. Do not let cord hang over edge of table or counter, or touch hot surfaces.
10. Do not place on or near a hot gas or electric burner, or in a heated oven.
11. Always attach plug to appliance first, then plug cord into wall outlet. To disconnect, turn any control to "off", then remove plug from wall outlet.
12. Do not use appliance for other than intended use.
13. Save these instructions.

## SAVE THESE INSTRUCTIONS

# CAUTION

This appliance is for household use only. Any servicing, other than cleaning and user maintenance, should be performed by an authorized service center. Do not immerse machine in water. To reduce the risk of fire or electric shock, do not disassemble the machine. There are no parts inside the machine serviceable by the user. Repair should be done by authorized service personnel only.

1. Check voltage to be sure that the voltage indicated on the nameplate corresponds with your voltage.
2. Never use warm or hot water to fill the water tank. Use cold water only.
3. Keep your hands and the cord away from hot parts of the appliance during operation.
4. Never clean with scrubbing powders or harsh cleaners. Simply use a soft cloth dampened with water.
5. For optimal taste of your coffee, use purified or bottled water. Periodic descaling is still recommended every 2-3 months.
6. Do not use caramelized or flavored coffee beans.

## INSTRUCTIONS FOR THE POWER SUPPLY CORD

- A. A short power-supply cord (or detachable power-supply cord) is to be provided to reduce risks resulting from becoming entangled in or tripping over a longer cord.
- B. Longer detachable power-supply cords or extension cords are available and may be used if care is exercised in their use.
- C. If a long detachable power-supply cord or extension cord is used,
  1. The marked electrical rating of the detachable power-supply cord or extension cord should be at least as great as the electrical rating of the appliance
  2. If the appliance is of the grounded type, the extension cord should be a grounding-type 3-wire cord, and
  3. The longer cord should be arranged so that it will not drape over the counter top or table top where it can be pulled on by children or tripped over.

*Congratulations on your purchase of a Saeco Intelia One Touch Cappuccino full automatic espresso machine! To fully benefit from the support that Saeco offers, please register your product at [www.philips.com/welcome](http://www.philips.com/welcome). This user manual applies to HD8753.*

*The machine is suitable for preparing espresso coffees using whole coffee beans. It is supplied with a milk carafe so you can prepare perfect Cappuccino in a quick and easy way. In this user manual you will find all the information you need to install, use, clean and descale your machine.*

## CONTENTS

<b>IMPORTANT.....</b>	<b>4</b>
Safety instructions .....	4
Warning .....	4
Caution .....	5
Compliance with standards .....	5
<b>INSTALLATION .....</b>	<b>6</b>
Product overview .....	6
General description .....	7
<b>PREPARING FOR USE .....</b>	<b>8</b>
Machine packaging .....	8
Machine installation.....	8
<b>USING THE MACHINE FOR THE FIRST TIME .....</b>	<b>10</b>
Circuit priming .....	10
Automatic rinse/self- cleaning cycle .....	11
Manual rinse cycle.....	12
Measuring and programming water hardness .....	14
"INTENZA+" water filter installation .....	15
Replacing the "INTENZA+" water filter.....	16
<b>ADJUSTMENTS.....</b>	<b>18</b>
Saeco Adapting System.....	18
Adjusting the ceramic coffee grinder .....	18
Adjusting the aroma (coffee strength) .....	19
Adjusting the dispensing spout.....	20
Adjusting the coffee length .....	21
<b>ESPRESSO AND COFFEE BREWING .....</b>	<b>22</b>
Espresso and coffee brewing using coffee beans .....	22
Espresso and coffee brewing using pre-ground coffee .....	23
<b>MILK CARAFE.....</b>	<b>24</b>
Filling the milk carafe.....	24
Inserting the milk carafe .....	25
Removing the milk carafe .....	26
Emptying the milk carafe .....	26

<b>CAPPUCCINO BREWING .....</b>	<b>27</b>
Adjusting the cappuccino length .....	28
<b>HOT MILK BREWING.....</b>	<b>30</b>
Adjusting the hot milk length .....	31
<b>HOT WATER DISPENSING .....</b>	<b>32</b>
<b>CLEANING AND MAINTENANCE .....</b>	<b>34</b>
Daily cleaning of the machine .....	34
Daily cleaning of the water tank.....	36
Daily cleaning of the milk carafe .....	36
Weekly cleaning of the machine .....	37
Weekly cleaning of the milk carafe.....	37
Weekly cleaning of the brew group.....	42
Monthly cleaning of the milk carafe.....	44
Monthly lubrication of the brew group .....	46
Monthly cleaning of the brew group with "Coffee Oil Remover" .....	48
Monthly cleaning of the coffee bean hopper.....	50
<b>DESCALING.....</b>	<b>50</b>
<b>PROGRAMMING .....</b>	<b>55</b>
Adjustable parameters.....	55
Programming mode example .....	56
<b>MEANING OF THE DISPLAY SYMBOLS.....</b>	<b>58</b>
<b>TROUBLESHOOTING.....</b>	<b>62</b>
<b>ENERGY SAVING.....</b>	<b>64</b>
Stand-by .....	64
Disposal .....	64
<b>TECHNICAL SPECIFICATION.....</b>	<b>65</b>
<b>GUARANTEE AND SERVICE .....</b>	<b>65</b>
Guarantee .....	65
Service .....	65
<b>ORDERING MAINTENANCE PRODUCTS .....</b>	<b>66</b>

**IMPORTANT****Safety instructions**

This machine is equipped with safety features. Nevertheless read the safety instructions carefully and only use the machine as described in these instructions to avoid accidental injury or damage. Keep this user manual for future reference.



The term **WARNING** and this sign warn against possible severe injuries, danger to life and/or damage to the machine.



The term **CAUTION** and this sign warn against slight injuries and/or damage to the machine.

**Warning**

- Connect the machine to a wall socket which is properly wired. Its main voltage should comply with the technical data of the appliance.
- Do not let the mains cord hang over the edge of a table or counter, or touch hot surfaces.
- Never immerse the machine, mains plug or mains cord in water (danger of electrical shock).
- Never direct the hot water jet towards body parts (danger of burning).
- Do not touch hot surfaces. Use handles and knobs.
- Remove the mains plug from the wall socket:
  - If a disturbance occurs.
  - If the machine will not be used for a long time.
  - Before cleaning the machine.

Pull on the plug, not on the mains cord. Do not touch the mains plug with wet hands.

- Do not use the machine if the mains plug, the mains cord or the machine itself is damaged.
- Do not make any modifications to the machine or its mains cord. Only have repairs carried out by a service centre authorized by Philips to avoid a hazard.
- This machine is not intended for use by persons (including children) with reduced physical, sensory or mental capabilities, or lack of experience and knowledge, unless they have been given supervision or instruction concerning use of the machine by a person responsible for their safety.
- Children should be supervised to ensure that they do not play with the machine.
- Never insert fingers or other objects into the coffee grinder.

---

**Caution**

---

- The machine is for household use only. It is not intended for use in environments such as staff kitchens of shops, offices, farms or other work environments.
- Always put the machine on a flat and stable surface.
- Do not place the machine on a hot plate, directly next to a hot oven, heater or similar source of heat.
- Only put coffee beans into the coffee bean hopper. If ground coffee, instant coffee or any other substance is put in, it may damage the machine.
- Allow the machine to cool before putting on or taking off .
- Never use warm or hot water to fill the water tank. Use cold water only.
- Never clean with scrubbing powders or harsh cleaners. Simply use a soft cloth dampened with water.
- Descale your machine regularly. The machine indicates when descaling is needed. Not doing this will make your appliance stop working properly. In this case repair is not covered under your warranty!
- Do not keep the machine at temperature below 0 degree Celsius. Residue water in the heating system may freeze and cause damage.
- Do not leave water in the water tank when the machine is not used over a longer period of time. The water can become contaminated. Use fresh water every time you use the machine.

---

**Compliance with standards**

---

The machine complies with art.13 of the Italian Legislative Decree dated 25 July 2005, no. 151 "Implementation of the directives 2005/95/EC, 2002/96/EC and 2003/108/EC on the restriction of the use of certain hazardous substances in electrical and electronic equipment, as well as waste disposal".

This machine complies with EU directive 2002/96/EC.

# INSTALLATION

## Product overview

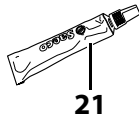
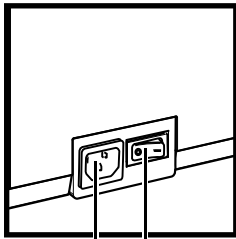
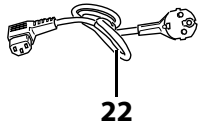
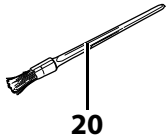
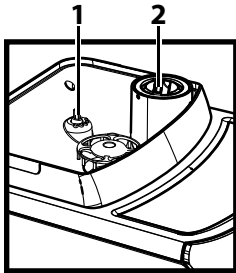

31

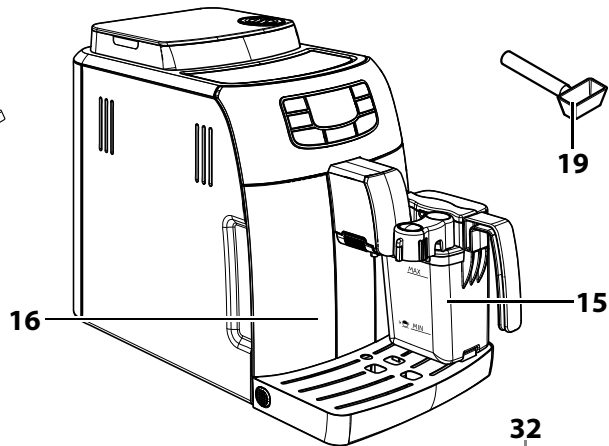
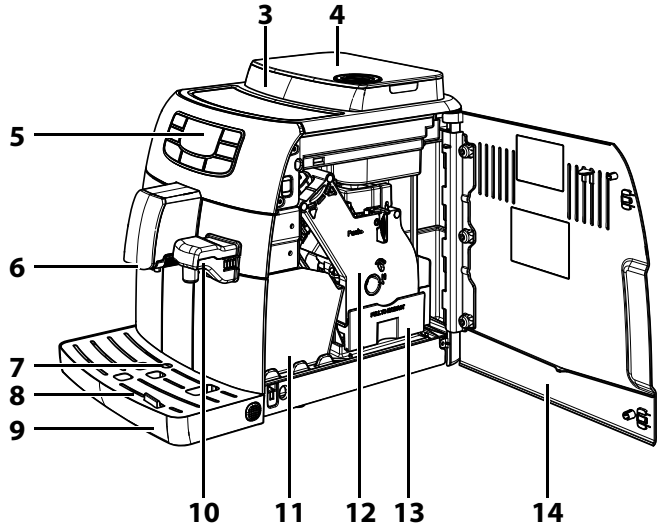
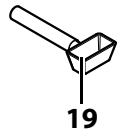
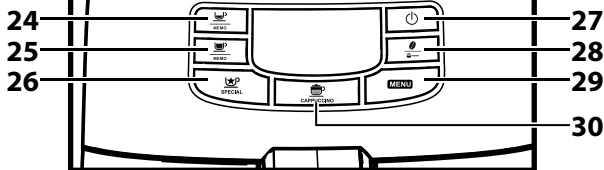
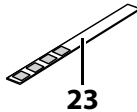

32





---

**General description**

---

1. Grinder adjustment knob
2. Pre-ground coffee compartment
3. Coffee bean hopper
4. Coffee bean hopper lid
5. Control panel
6. Dispensing spout
7. Full drip tray indicator
8. Cup holder grill
9. Drip tray
10. Water dispenser (removable)
11. Coffee grounds drawer
12. Brew group
13. Coffee residues drawer
14. Service door
15. Milk carafe
16. Water tank
17. Power cord socket
18. Power button
19. Coffee grinder adjustment key + Pre-ground coffee doser
20. Cleaning brush
21. Grease for the brew group
22. Power cord
23. Water hardness test
24. Espresso brew button
25. Coffee brew button
26. Special beverages selection button
27. ON/OFF button
28. "Aroma" - Pre-ground coffee button
29. "MENU" button
30. Cappuccino brew button
31. Descaling solution - to be purchased separately
32. Filter (INTENZA+) - to be purchased separately

## PREPARING FOR USE

### Machine packaging

The original packaging has been designed and constructed to protect the machine during transport. We recommend keeping the packaging material for possible future transport.

### Machine installation

**1** Remove the drip tray with grill from the packaging.

**2** Remove the machine from the packaging.

**3** For best use, it is recommended to:

- Choose a safe, level surface, where there will be no danger of overturning it or being injured.
- Choose a location that is sufficiently well-lit, clean and near an easily reachable socket.
- Allow for a minimum distance from the sides of the machine as shown in the illustration.

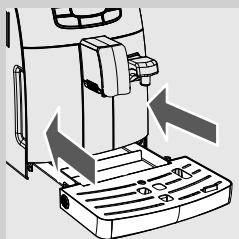
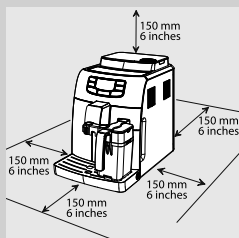

**4** Attach the drip tray with grill to the machine. Make sure it is fully inserted.



#### Note:

The drip tray collects the water that comes out of the dispensing spout during each rinse/self-cleaning cycle as well as coffee that might be spilled during beverage preparation. Empty and clean the drip tray daily and each time the full drip tray indicator is raised.

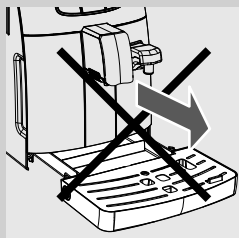

#### Caution:

**NEVER** remove the drip tray when the machine has just been turned on. Wait a couple of minutes, since the machine will carry out a rinse/self-cleaning cycle.

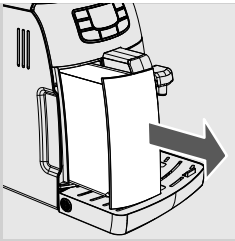

**5** Remove the water tank.

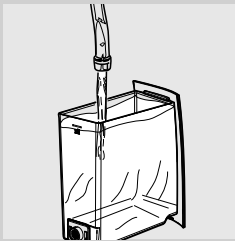

**6** Rinse the water tank under fresh water.

**7** Fill the water tank with fresh water up to the MAX level and reinsert it into the machine. Make sure it is fully inserted.



**Caution:**

**Never fill the water tank with warm, hot, sparkling water or any other liquid, as this may cause damage to the water tank and the machine.**



**8** Remove the coffee bean hopper lid and slowly pour the coffee beans into the coffee bean hopper.



**Note:**

Do not pour too many coffee beans into the coffee bean hopper as this will reduce the grinding performance of the machine.



**Caution:**

**Only coffee beans must be put into the coffee bean hopper. Ground coffee, instant coffee, caramelized coffee or any other object may damage the machine.**

**9** Put the lid on the coffee bean hopper.

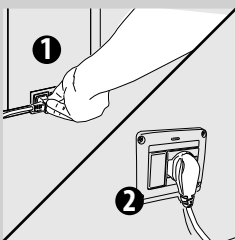

**10** Insert the plug into the socket located on the back of the machine.

**11** Insert the plug of the other end of the power cord into a wall socket with suitable power voltage.

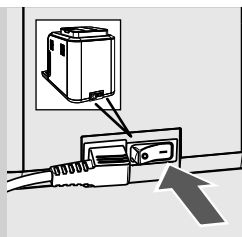

Black

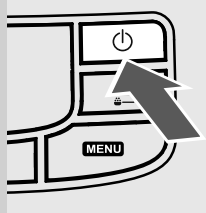

Yellow

**12** Switch the power button to “I” to turn on the machine. The display shows the stand-by icon.

**13** To turn on the machine, simply press the “” button. The display indicates that the circuit must be primed.

## USING THE MACHINE FOR THE FIRST TIME

When using the machine for the first time, the following activities need to happen:

- 1) You need to prime the circuit
- 2) The machine will perform an automatic rinse/ self-cleaning cycle
- 3) You need to initiate a manual rinse cycle

### Circuit priming

During this process fresh water flows through the internal circuit of the machine and the machine warms up. This takes a few minutes.

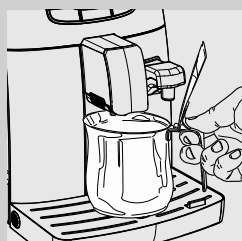

**1** Place a container under the dispensing spout.

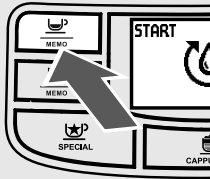

- 2 Press the “” button to start the cycle. The machine starts the automatic priming of the circuit by dispensing some water through the dispensing spout.



Yellow

- 3 The bar under the icon shows the operation progress. When the process is completed, the machine stops dispensing automatically.

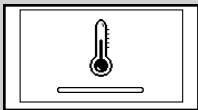

Yellow

- 4 Then the display shows the machine warm-up icon.

### Automatic rinse/self- cleaning cycle

When warm-up is completed, the machine automatically performs a rinse/self- cleaning cycle of the internal circuit with fresh water. This takes less than a minute.

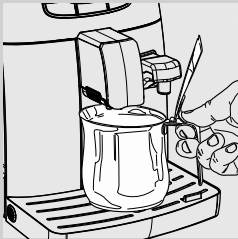

- 5 Place a container under the dispensing spout to catch the small amount of water which will be dispensed.



Yellow

- 6 The machine shows this display. Wait for the cycle to finish automatically.



**Note:**

You can stop dispensing by pressing the “” button.

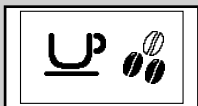

Green

- 7 When the above steps are completed, the machine shows this display.

### Manual rinse cycle

During this process you activate the coffee brewing cycle and fresh water flows through dispensing spout. This takes a few minutes.



- 1 Place a container under the dispensing spout.

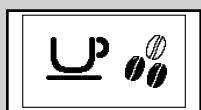

Green

- 2 Check that the machine shows this display.

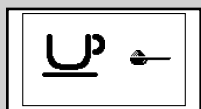

Green

- 3 Select the pre-ground coffee brewing function by pressing the "☕" button. The machine shows this display.



**Note:**

Do not add pre-ground coffee into the compartment.

- 4 Press the "☕ MEMO" button. The machine starts dispensing water.

- 5 When the dispensing has finished, empty the container. Repeat the operations from step 1 to step 4 twice, then continue with step 6.

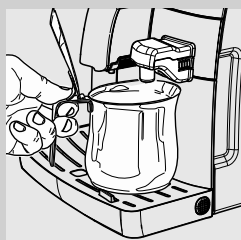

- 6 Place a container under the water dispensing spout.

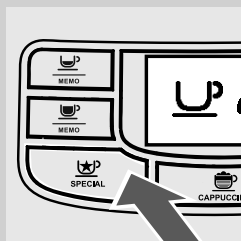



- 7 Press the "☕ SPECIAL" button.

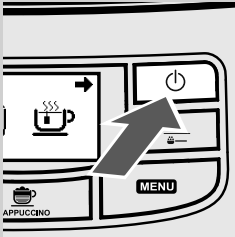

Green

8 The following icon is displayed.



9 Press the “” button to start dispensing hot water.

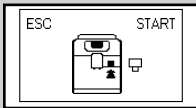

Green

10 This icon is displayed. The machine reminds you to install the water dispensing spout. Check that it is correctly installed. Press “” to confirm. The machine will start dispensing hot water.



Red

11 Dispense water until the no water icon appears.

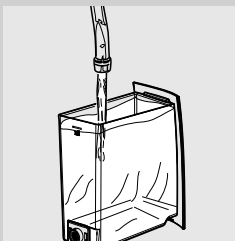

12 At the end, fill the water tank again up to the MAX level. Now the machine is ready for brewing coffee.



**Note:**

When you haven't used the machine for 2 or more weeks, the machine will automatically perform an automatic rinse/self-cleaning cycle after you switch it on. Thereafter you need to initiate the manual rinse cycle including brewing a coffee as described above.

The automatic rinse/self-cleaning cycle is also initiated automatically when starting up the machine (with cold boiler), when the machine is preparing to go into stand-by mode or after you have pressed the “” button (after a coffee has been brewed).

**Measuring and programming water hardness**

Measuring water hardness is very important for defining the frequency in which the machine has to be descaled and to install the "INTENZA+" water filter (for more detail on the water filter see next chapter).

To measure the water hardness follow the steps below:

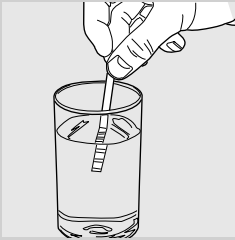

- 1 Immerse the water hardness test strip (supplied with the machine) in water for 1 second.



**Note:**

The test strip can only be used for one measurement.

- 2 Wait for one minute.

- 3 Check how many squares have changed the colour to red and then consult the table.



**Note:**

The numbers on the water hardness test strip correspond to the water hardness adjustment settings.

- More precisely:
- 1 = 1 (very soft water)
  - 2 = 2 (soft water)
  - 3 = 3 (hard water)
  - 4 = 4 (very hard water)

The letters correspond to the references that are located at the base of the "INTENZA+" water filter. (see next chapter for this).

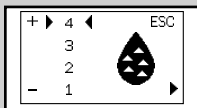
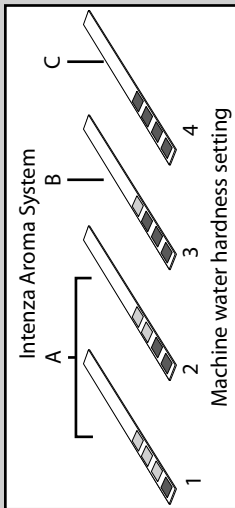

- 4 Now you can program the water hardness setting.  
Press the "MENU" button and scroll the pages by pressing the "▲" button until the following icon is displayed.



**Note:**

The machine is supplied with standard water hardness setting, suitable for most of the type of water.

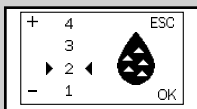

- 5 Press the "▲" button to increase the value or the "▼" button to decrease the value.
- 6 Press the "●" button to confirm the setting.





Green

- 7** Press the “” button to exit the programming menu.

### “INTENZA+” water filter installation

We recommend you to install the “INTENZA+” water filter as this prevents lime scale to build up in your machine and preserves a more intense aroma to your espresso coffee.

You can purchase separately the INTENZA+ water filter. Please refer to the maintenance products page in this user manual for further details. Water is a crucial part of every espresso, so it’s most important to always have it professionally filtered. Using the “INTENZA+” water filter will prevent mineral deposits from building up and improve your water quality.

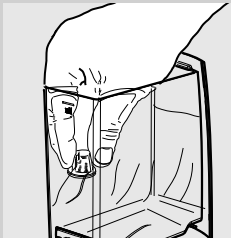

- 1** Remove the small white filter from the water tank and store it in a dry place.



- 2** Remove the “INTENZA+” water filter from its packaging, immerse it vertically (with the opening positioned upwards) in cold water and gently press the sides so as to let the air bubbles out.

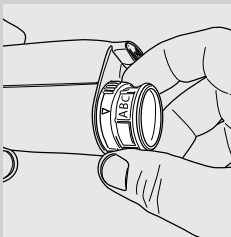

- 3** Set the filter according to the measurements performed (see previous chapter) and indicated on the base of the filter:  
 A = Soft water – equals 1 or 2 on the test strip  
 B = Hard water (standard) – equals 3 on the test strip  
 C = Very hard water – equals 4 on the test strip

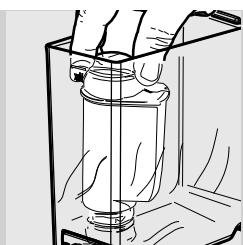

- 4 Put the filter into the empty water tank. Press it until it cannot move further down.
- 5 Fill the water tank with fresh water and reinsert it into the machine.
- 6 Dispense the entire water tank by using the hot water function (see chapter "Hot water dispensing").
- 7 Fill the water tank again.

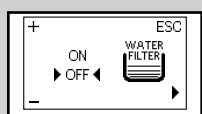

Yellow

- 8 Press the "MENU" button and scroll the pages by pressing the "☉" button until the following page is displayed.

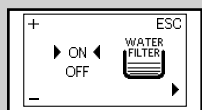

Yellow

- 9 Press the "MEMO" button to select "ON" and press the "☉" button to confirm.

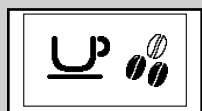

Green

- 10 To exit, press the "☉" button.

In this way the machine has been programmed to inform the user of the need to replace the "INTENZA+" water filter.

### Replacing the "INTENZA+" water filter

When the "INTENZA+" water filter needs to be replaced with a new one, the following icon is displayed.

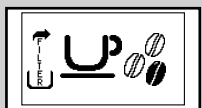

Yellow

- 1 Replace the filter as described in the previous chapter.

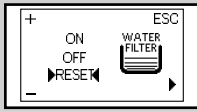

Yellow

2 Press the "MENU" button and scroll the pages by pressing the " " button until the following icon is displayed.

3 Select the "RESET" option. Press the " " button to confirm.



Green

4 To exit, press the " " button

The machine is now programmed to manage a new filter.

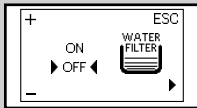

Yellow



**Note:**

If the filter is already installed and you want to remove - but not replace - it, select the "OFF" option instead.

If there is no "INTENZA+" water filter installed, insert the small white filter previously removed into the water tank.

## ADJUSTMENTS

The machine allows for certain adjustments so that you can brew the best tasting coffee possible.

### Saeco Adapting System

Coffee is a natural product and its characteristics may change according to its origin, blend and roast. The machine is equipped with a self-adjusting system that allows the use of all types of coffee beans available on the market (not for caramelized beans).

The machine automatically adjusts itself after brewing several cups of coffee to optimize the extraction of the coffee to the compactness of the ground coffee.

### Adjusting the ceramic coffee grinder

Ceramic coffee grinders always guarantee accurate grinding for every coffee blend and prevent the beans from overheating. This provides for full aroma preservation, delivering the truly Italian taste in every cup.



#### Warning:

**The ceramic coffee grinder contains moving parts that may be dangerous. Therefore, do not insert fingers and/ or other objects. Only adjust the ceramic coffee grinder using the grinder adjustment key. Turn off the machine by pressing the ON/OFF button and remove the plug from the socket before carrying out any type of operation inside the coffee bean hopper.**

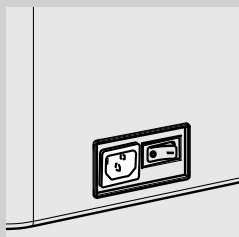

You can adjust the ceramic grinders to set the coffee grinding to your personal taste.



#### Warning:

**The grinder adjustment knob, inside the coffee bean hopper, must be turned only when the ceramic coffee grinder is working.**

This adjustment can be carried out by pressing and turning the grinder adjustment knob inside the coffee bean hopper, using the grinder adjustment key provided with the machine.

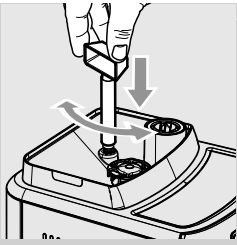

**1** Press and turn the grinder adjustment knob one notch at a time. You will taste the difference after brewing 2-3 cups of espresso.

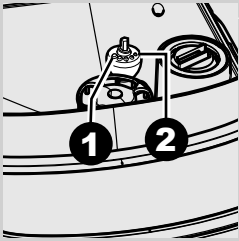

**2** The reference marks inside the coffee bean hopper indicate the grind setting. There are 5 different grind settings to choose from:

- 1 - Coarse grind: lighter taste, for dark roasted coffee blends to
- 2 - Fine grind: bolder taste, for light roasted coffee blends

When you adjust the ceramic coffee grinder to a finer setting, your coffee will taste stronger. For a milder coffee taste, adjust the ceramic coffee grinder to a coarser setting.

### Adjusting the aroma (coffee strength)

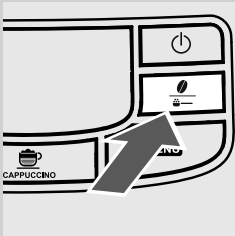

Choose your favorite coffee blend and adjust the amount of coffee to be grounded until they meet your personal taste. You can also select the pre-ground coffee function.



**Note:**

Selection must be made prior to selecting coffee.

Four choices are possible by pressing the “☕” button. Each time the “☕” button is pressed, the aroma changes by one degree, according to the selected amount:

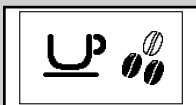

Green

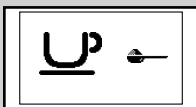

Green

- ☕☕☕ = Mild aroma
- ☕☕☕ = Medium aroma
- ☕☕☕ = Strong aroma
- ☕☕☕ = Pre-ground coffee

### Adjusting the dispensing spout

The height of the dispensing spout can be adjusted to better fit the dimensions of the cups that you wish to use.

Move the dispensing spout up or down with your fingers to adjust its height as shown in the image.

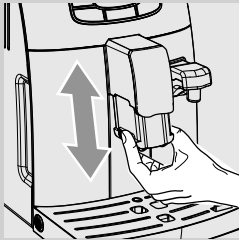

The recommended positions are:  
For the use of small cups;



For the use of large cups.





Two cups can be placed under the dispensing spout to brew two cups of coffee at the same time.



## Adjusting the coffee length

The machine allows you to adjust the amount of brewed coffee according to your taste and/or the size of your cups.

Each time the “” or “” button is pressed, the machine brews a pre-set amount of coffee. Each button may be individually programmed for a specific brew setting.

The following procedure describes the programming of the “” button.

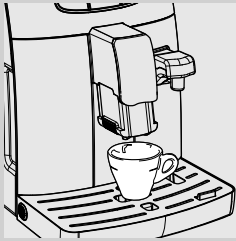

- 1 Place a cup under the dispensing spout.





Green

- 2 Press and hold the “” button until the “MEMO” icon is displayed. Then release the button. The machine is now programming. The machine starts brewing coffee.





Green

- 3 When the “STOP” icon is displayed, press the “” button as soon as the desired amount of coffee is reached.

Now the “” button is programmed; each time it is pressed, the machine will brew the same amount of espresso that was just programmed.



### Note:

To program the coffee “” button, the same steps should be followed. You should always using the “” button to stop brewing coffee when the desired amount of coffee is reached. Even when you are programming the coffee “” button.

## ESPRESSO AND COFFEE BREWING

Before brewing coffee, make sure that there are no warnings shown on the display, and that both, water tank and coffee bean hopper are filled.

### Espresso and coffee brewing using coffee beans

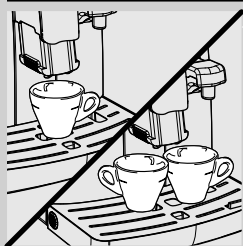

- 1 Place 1 or 2 cups under the dispensing spout.

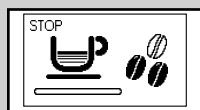

Green

- 2 To brew an espresso or a coffee, press the "☕" button to select the desired aroma.

- 3 Press the "☕ MEMO" button for an espresso or the "☕ MEMO" button for a coffee.

- 4 To brew 1 cup of espresso or coffee, press the desired button once. This icon will be displayed.



Green

- 5 To brew 2 cups of espresso or coffee, press the desired button twice consecutively. This icon will be displayed.



#### Note:

In this operating mode, the machine automatically grinds and doses the correct amount of coffee. Brewing two espressos requires two grinding and brewing cycles, automatically carried out by the machine.

- 6 After the pre-brewing cycle, coffee begins to pour out of the dispensing spout.

- 7 Coffee brewing stops automatically when the pre-programmed level is reached; however, it is possible to stop earlier by pressing the "☕ MEMO" button.



### Espresso and coffee brewing using pre-ground coffee

This function allows to use pre-ground and decaffeinated coffee.

With the pre-ground coffee function you can only brew one coffee at a time.



Green





**1** Press the “” button to select the pre-ground coffee function.

**2** Lift the pre-ground coffee compartment lid and add one scoop of pre-ground coffee to the compartment. Use only the measuring scoop supplied with the machine. Then close the pre-ground coffee compartment lid.



**Warning:**

**Add only pre-ground coffee to the pre-ground coffee compartment. Other substances and objects may cause severe damages to the machine. Such damages are not covered by your warranty.**

**3** Press the “” button for an espresso or “” button for a coffee. The brewing cycle starts.

**4** After the pre-brewing cycle, coffee begins to pour out of the dispensing spout.

**5** Coffee brewing stops automatically when the pre-programmed level is reached; it is possible to stop earlier by pressing the “” button.

After brewing the product, the machine returns to the main menu.

Repeat the steps described above to brew more coffees using pre-ground coffee.



**Note:**

If no pre-ground coffee is poured into the compartment, only water will be dispensed.

If the dose is excessive and 2 or more measuring scoops of coffee are used, the machine will not brew the product. Only water will be dispensed and any ground coffee will be discharged into the coffee grounds drawer.

## MILK CARAFE

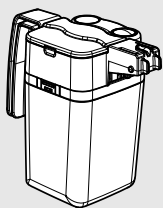

This chapter explains how to use a milk carafe to prepare a cappuccino or hot milk.



### Note:

Before using the milk carafe, clean it thoroughly as described in the “Cleaning and Maintenance” chapter.

We recommend to fill it with cold milk (approx. 5°C). After use, put the carafe back in the refrigerator. DO NOT leave the milk out of the refrigerator for more than 15 minutes.



### Warning:

**Do not pour any other liquid than water for cleaning or milk.**

## Filling the milk carafe

The milk carafe can be filled before use or even during use.

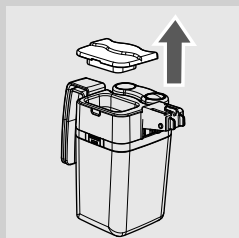

- 1 Lift the top of the carafe as shown in the figure.



- 2 Pour the milk into the milk carafe: the milk level must be between the minimum (MIN) and maximum (MAX) level indicator shown on the milk carafe.

- 3 The milk carafe is now ready to use.

### Inserting the milk carafe

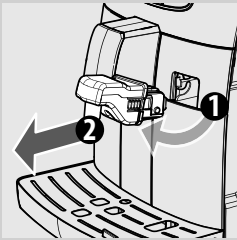

- 1** If installed, remove the water dispenser as shown in the figure:
- Press the two buttons on the side to unlock it and lift it slightly;
  - Pull the water dispenser to remove it.

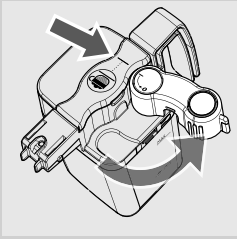

- 2** Open the milk carafe dispenser by turning it counter-clockwise until it locks into place.

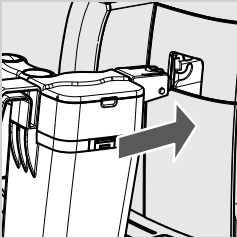

- 3** Slightly tilt the milk carafe and then insert the front part into guides of the machine.

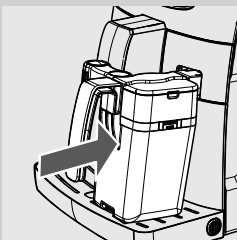

- 4** Insert the carafe all the way into the guides.

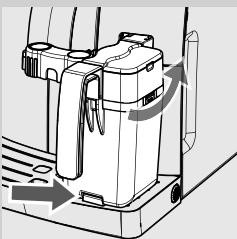

- 5** Push the carafe towards the bottom while rotating at the same time, until it is locked at the drip tray.  
Do not use force while inserting the carafe.

### Removing the milk carafe

---

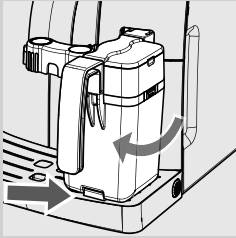

- 1 Rotate the carafe upwards until it releases from the insert in the drip tray.

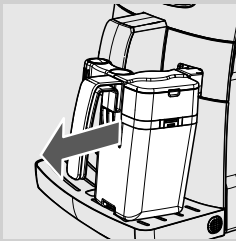

- 2 Pull away from the machine until it is completely detached.
- 3 Close the milk carafe dispenser by turning it clockwise.

### Emptying the milk carafe

---

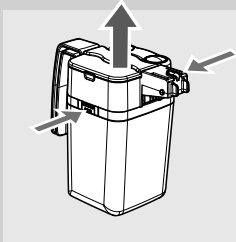

- 1 Press the release buttons to allow the lid removal.

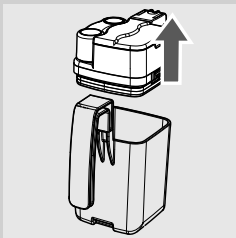

- 2 Lift the lid. Empty the milk carafe and clean it properly.



**Note:**

After each use, clean the milk carafe as described in the "Cleaning and Maintenance" chapter.

## CAPPUCCINO BREWING

**Warning:**

**Danger of scalding! Dispensing may be preceded by short sprays of milk and steam. Risk of burning. Wait until the end of the cycle before removing the milk carafe.**

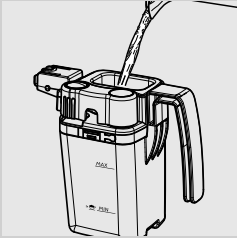

- 1 Fill the milk carafe with milk. The level must be between the minimum (MIN) and maximum (MAX) indication on the milk carafe.

**Note:**

Use cold (~5°C / 41°F) milk with a protein content of at least 3% to ensure optimum results when preparing a cappuccino. You can use whole milk or low-fat milk depending on your personal taste.

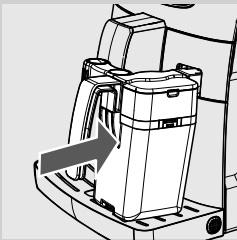

- 2 Open the milk carafe dispenser and insert the milk carafe into the machine.



- 3 Place a cup under the dispensing spout.

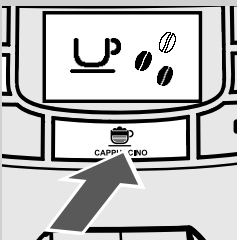

- 4 Press the "  " button to start brewing process.

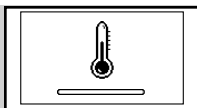

Yellow

- 5** The following icon is displayed during pre-heating time required by the machine.



Green

- 6** When the machine shows the following icon, the machine pours a milk. The pouring can be stopped by pressing the "MEMO" button.



Green

- 7** Once the milk froth has been poured, the machine brews coffee. The pouring can be stopped by pressing the "MEMO" button.

**Note:**

After using the milk carafe, clean it as described in the 'Cleaning and Maintenance' chapter.

It is possible to prepare a cappuccino with pre-ground coffee. Press the "MEMO" button to select pre-ground coffee and pour the pre-ground coffee into the compartment.

### Adjusting the cappuccino length

Each time the "CAPPUCCINO" button is pressed, the machine pours a pre-set quantity of cappuccino into the cup.

The machine allows you to adjust the amount of brewed cappuccino according to your taste and the size of your cups.

- 1** Fill the milk carafe with milk and install it into the machine.
- 2** Place a cup under the dispensing spout.

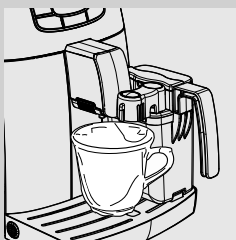

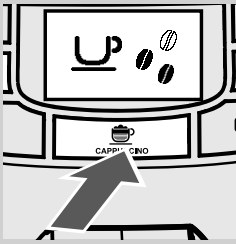

**3** Press and hold the “” button until the ‘MEMO’ icon appears on the display. Then release the button. The machine is now programming.

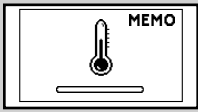

Yellow

**4** The following icon is displayed during pre-heating time required by the machine.





Green

**5** When the machine shows the following icon, the machine starts to pour milk froth into the cup. When the desired milk froth quantity is reached, press the “” button.



Green

**6** Once the milk froth has been poured, the machine starts brewing coffee. When the desired coffee quantity is reached, press the “” button.

Now the “” button is programmed. Every time it is pressed, the machine will brew the same amount of cappuccino that was programmed.

## HOT MILK BREWING

**Warning:**

**Danger of scalding! Dispensing may be preceded by short sprays of milk and steam. Risk of burning.**

**Wait until the end of the cycle before removing the milk carafe.**

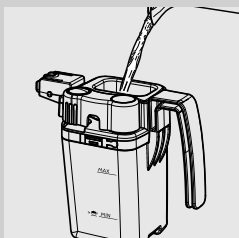

- 1 Fill the milk carafe with milk. The level must be between the minimum (MIN) and maximum (MAX) indication on the milk carafe.

**Note:**

Use cold (~5°C / 41°F) milk with a protein content of at least 3% to ensure optimum results when preparing a cappuccino. You can use whole milk or low-fat milk depending on your personal taste.

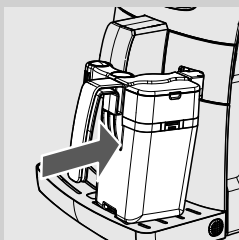

- 2 Open the milk carafe dispenser and insert the milk carafe into the machine.



- 3 Place a cup under the dispensing spout.



Green

- 4 Press the "  " button. The following icon is displayed.

- 5 Press the "  " button to select hot milk.



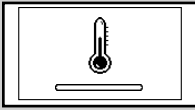

Yellow

- 6 The following icon is displayed during pre-heating time required by the machine.



Green

- 7 The machine pours a pre-defined amount of hot milk into the cup. The pouring can be stopped by pressing the "MEMO" button.



**Note:**

After using the milk carafe, clean it as described in the 'Cleaning and Maintenance' chapter.

**Adjusting the hot milk length**

Each time this function is selected, the machine pours a pre-set amount of hot milk into the cup. The machine allows you to adjust the amount of hot milk according to your taste and the size of your cups.

- 1 Fill the milk carafe with milk and install it into the machine.
- 2 Place a cup under the dispensing spout.



Green

- 3 Press the "MEMO" button. The following icon is displayed.
- 4 Press and hold the "MEMO" button to select hot milk until the 'MEMO' icon appears on the display. Then release the button. The machine is now in programming.

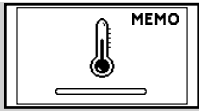

Yellow

- 5** The following icon is displayed during pre-heating time required by the machine.



Green

- 6** When the desired amount of hot milk is reached, press the "MEMO" button.

Now the hot milk is programmed. Every time it is pressed, the machine will brew the same amount of hot milk that was programmed.

## HOT WATER DISPENSING



**Warning:**  
**Danger of scalding! Dispensing may be preceded by short sprays of hot water and steam. Risk of burning. Wait until the end of the cycle before removing the water dispenser.**

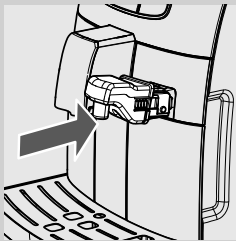

- 1** Slightly tilt the water dispenser and then insert it all the way in into the guides in the machine.

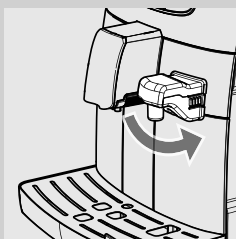

- 2** Push the water dispenser towards the bottom while rotating at the same time, until it is locked in the machine as shown in the figure.



**3** Place a container under the hot water dispenser.



Green

**4** Press the "☕  
SPECIAL" button. The following icon is displayed.

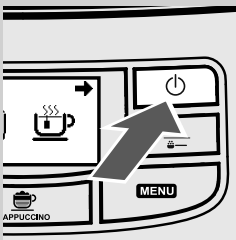

**5** Press the "⏻" button to start dispensing process.

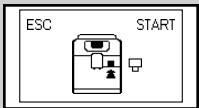

Green

**6** This icon is displayed. The machine reminds you to install the water dispenser. Check that it is correctly installed. Press "⏻" to confirm. The machine will start dispensing hot water.

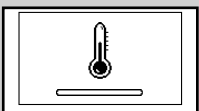

Yellow

**7** The following icon is displayed during pre-heating time required by the machine.



Green

- 8** Pour the desired amount of hot water. To stop the hot water dispensing process press the “” button.

## CLEANING AND MAINTENANCE

### Daily cleaning of the machine



#### Caution:

**Timely cleaning and maintenance of your machine is very important as it prolongs the life of your machine. Your machine gets exposed to moist, coffee and lime scale continuously!**

**In this chapter it is described in detail which activities you need to perform at which frequency. Not doing this will ultimately make your machine stop working properly. This repair is NOT covered by your warranty!**



#### Note:

- Use a soft, dampened cloth to clean the machine.
- Do not wash any of its parts in the dishwasher.
- Do not immerse the machine in water.
- Do not use alcohol, solvents, and/or abrasive objects to clean the machine.
- Do not dry the machine and/or its components using a microwave and/or standard oven.

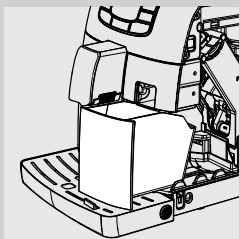

- 1** Empty and clean the coffee grounds drawer daily with the machine turned on.

Other maintenance operations can only be carried out when the machine is turned off and unplugged.

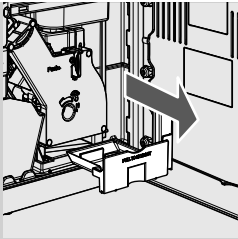

- 2** Empty and clean the coffee residues drawer located inside of the machine. Open the service door, remove the drawer and empty the coffee residues.

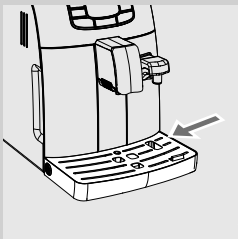

- 3** Empty and clean the drip tray:

- Press the side buttons to allow tray removal
- Remove the drip tray

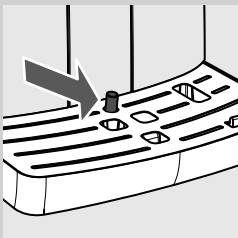
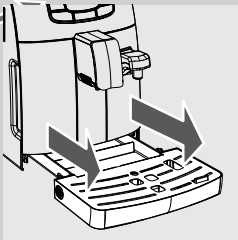

 **Note:**

Perform this operation also when the full drip tray indicator is raised.

### Daily cleaning of the water tank

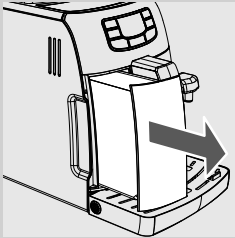

- 1** Remove the small white filter or the INTENZA+ water filter (if installed) from the water tank and wash it with fresh water.
- 2** Put the small white filter back or the INTENZA+ water filter (if installed) in its housing by gently pressing and turning it at the same time.
- 3** Fill the water tank with fresh water.

### Daily cleaning of the milk carafe

It is important that you clean the milk carafe daily or after each use as it preserves hygiene and ensures perfect milk froth consistency

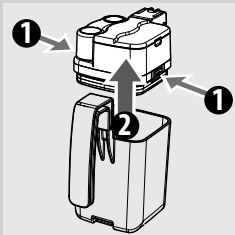

- 1** Press the release buttons to remove the lid.

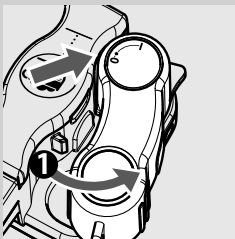

- 2** Turn the milk dispensing spout up to the (●) reference mark.

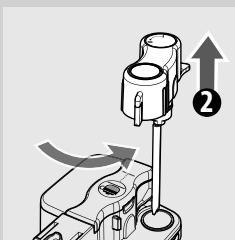

- 3** Lift the milk carafe dispenser to remove it from the lid.
- 4** Wash it with fresh water.
- 5** Put the milk carafe dispenser back into the carafe lid.

### Weekly cleaning of the machine

---

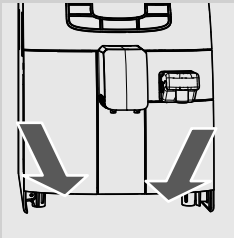

**1** Clean the seat of the drip tray.

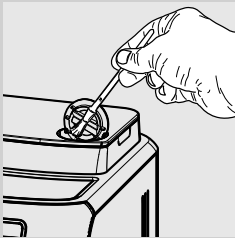

**2** Clean the pre-ground coffee compartment with the cleaning brush.

### Weekly cleaning of the milk carafe

---

The weekly cleaning is more thorough as it removes any milk residues from the milk carafe dispenser.

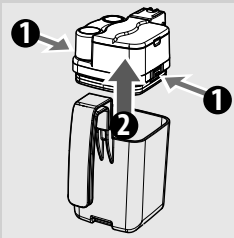

**1** Press the release buttons to remove the lid.

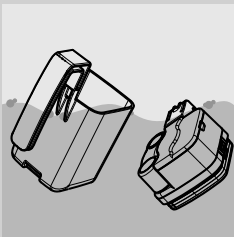

**2** Rinse the lid and the milk carafe with fresh water. Remove all milk residues.

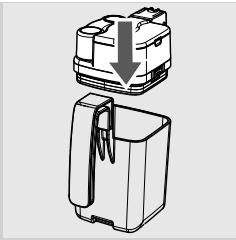

**3** Attach the lid on the milk carafe; ensure it is locked into place.

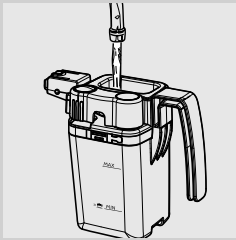

**4** Remove the top and fill the milk carafe up to the MAX level with fresh water.

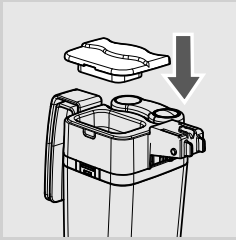

**5** Put the top back into the milk carafe.

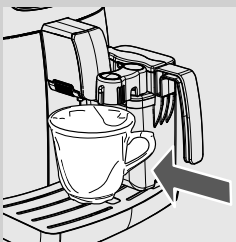



**6** Open the milk carafe dispenser and insert the carafe into the machine.

**7** Place a container under the dispensing spout.



Green

**8** Press the "  " button. The following icon is displayed. Press the "  " button to select hot milk.



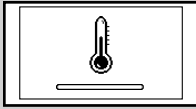

Yellow

**9** The following icon is displayed during pre-heating time required by the machine.



Green

**10** Once the machine stops dispensing water, the cleaning is finished. Remove the milk carafe and empty it.

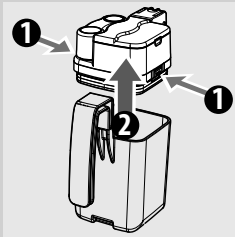

**11** Press the release buttons to remove the lid.

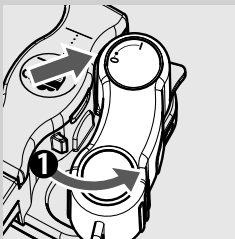

**12** Turn the milk carafe dispenser up to the (●) reference mark.

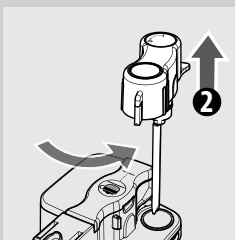

**13** Lift the milk carafe dispenser to remove it from the lid. The milk carafe dispenser consists of six pieces which you need to disassemble. Each individual piece is identified with capital letters (A-E) described in the steps images below.

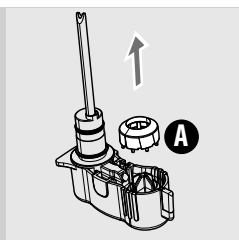

**14** Remove the dispenser ring (A) from the milk carafe dispenser.

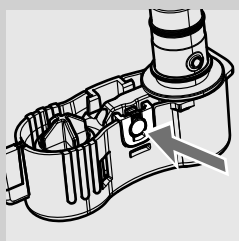

**15** Press the button indicated with the arrow to unlock the lid.

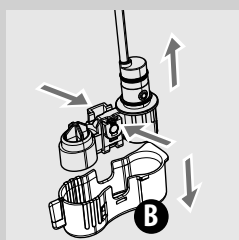

**16** Detach the lid (B) from the milk carafe dispenser by pulling it down while slightly pressing on the sides.

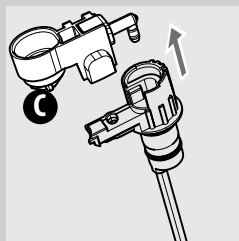

**17** Pull the milk frothing device (C) upwards.

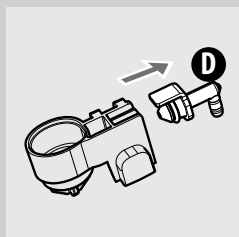

**18** Pull the fitting (D) outwards from the milk frothing device.

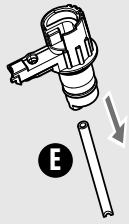

19 Remove the suction tube (E).

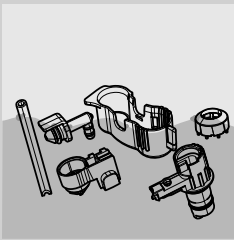

20 Clean thoroughly all the parts with lukewarm water.



**Note:**

You can also clean these parts in the dishwasher.

21 Reassemble the parts following the reverse order.



**Note:**

As explained at step 13, the dispenser can only be inserted into the lid, when it is in the reference (●) position.

### Weekly cleaning of the brew group

The brew group should be cleaned every time the coffee bean hopper is filled or at least once a week.

**1** Turn off the machine by pressing the "⏻" button and remove the plug from the socket.

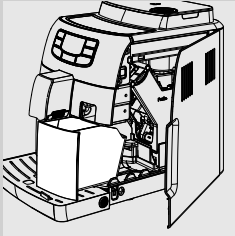

**2** Remove the coffee grounds drawer. Open the service door.

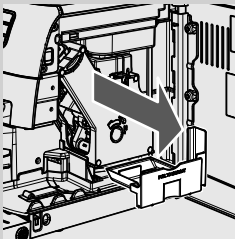

**3** Remove and clean the coffee residues drawer.

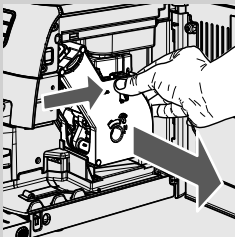

**4** To remove the brew group, press the «PUSH» button and pull it by the handle.

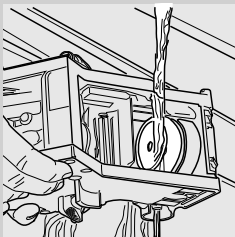

**5** Thoroughly wash the brew group with fresh, lukewarm water and carefully clean the upper filter.



**Caution:**

**Do not use detergent/ soap to clean the brew group.**

**6** Let the brew group air-dry thoroughly.

**7** Thoroughly clean the inside of the machine using a soft, dampened cloth.

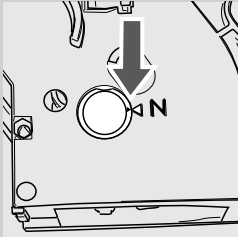

**8** Make sure the brew group is in the rest position; the two reference signs must match. If they do not match, proceed as described in step (9).

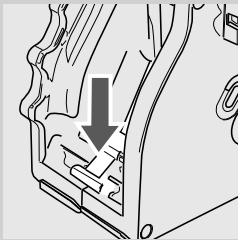

**9** Gently pull down the lever until it is in contact with the brew group base and the two reference signs on the side of the brew group do match.

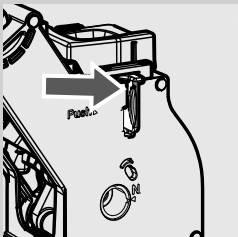

**10** Make sure the hook to lock the brew group is in the correct position by firmly pressing the "PUSH" button until you hear a click. Check if the hook is at the top end position. If it is not, please try again.

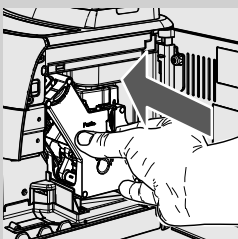

**11** Insert the brew group in its seat again until it locks into place without pressing the "PUSH" button.

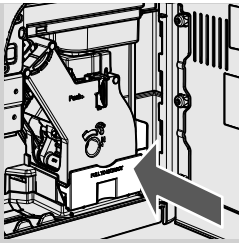

**12** Insert the coffee residues drawer and close the service door.

**13** Insert the coffee grounds drawer.

### Monthly cleaning of the milk carafe

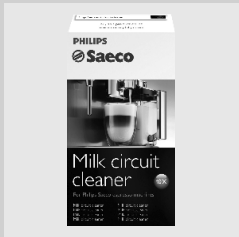

In the monthly cleaning cycle we use the “Saeco Milk Circuit Cleaner” to keep the entire circuit of milk residues. You can purchase separately the “Saeco Milk Circuit Cleaner”. Please refer to the maintenance products page for further details.



**Warning:**

**Danger of scalding! Dispensing may be preceded by short sprays of hot water and steam. Risk of burning. Wait until the end of the cycle before removing the milk carafe.**



**Note:**

Before starting the procedure, make sure that the water tank is filled up to the MAX level.

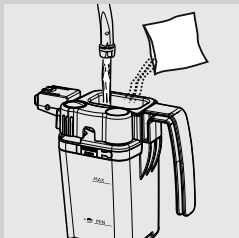

**1** Fill the milk carafe with water up to the maximum level (MAX).

**2** Pour the milk cleaner bag into the milk carafe and let it dissolve completely.

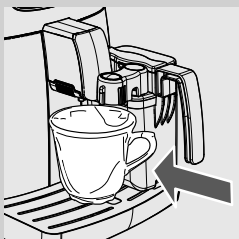

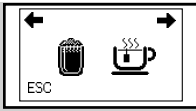

**3** Insert the milk carafe into the machine.

**4** Place a container under the dispensing spout.



Green

**5** Press the "  " button. The following icon is displayed. Press the "  " button to select hot milk.

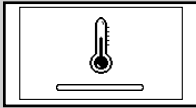

Yellow

**6** The following icon is displayed during pre-heating time required by the machine.



Green

**7** Once the machine stops dispensing water, repeat steps 5 - 8 until the carafe is emptied.



**Warning:**  
**Never drink the solution dispensed during the procedure.**

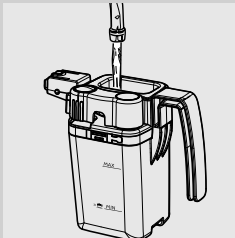

**8** Remove the milk carafe and the container from the machine.

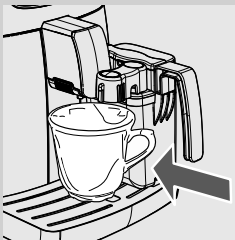

**9** Rinse and fill the milk carafe with fresh water up to the MAX level.



**10** Insert the milk carafe into the machine and place a container under dispensing spout to start the rinsing cycle.



Green

**11** Press the "  " button. The following icon is displayed. Press the "  " button to select hot milk.

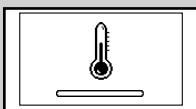

Yellow

**12** The following icon is displayed during pre-heating time required by the machine.

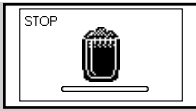

Green

- 13** Once the machine stops dispensing water, repeat steps 12 -15 until carafe is emptied.
- 14** Remove the milk carafe and the container from the machine. Repeat steps 10 - 16 one more time.
- 15** Disassemble and wash the milk carafe as described in the “Weekly cleaning of the milk carafe” chapter.

### Monthly lubrication of the brew group

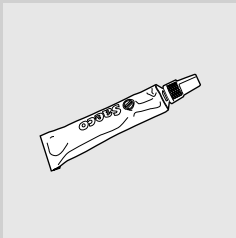

Lubricate the brew group after approximately 500 cups of coffee or once a month. You can purchase separately the Saeco grease to lubricate the brew group. Please refer to the maintenance products page in this user manual for further details.



**Caution:**

**Before lubricating the brew group, clean it under fresh water and dry it, as described in the “Weekly cleaning of the brew group” chapter.**

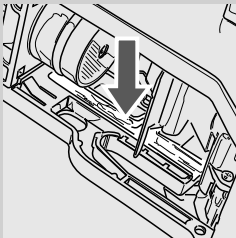

- 1** Apply the grease evenly on both side guides.

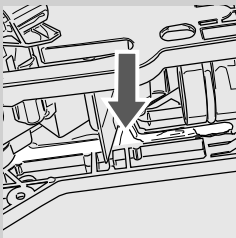



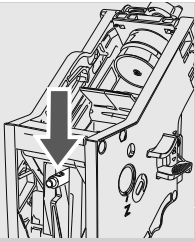

**2** Lubricate the shaft too.

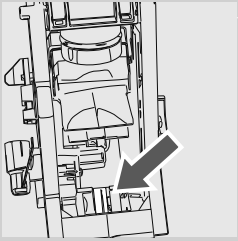

**3** Insert the brew group in its seat until it locks into place. (see "Weekly cleaning of the brew group" chapter). Insert the coffee residues drawer.

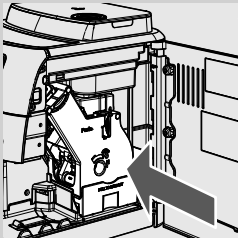

**4** Close the service door. Insert the coffee grounds drawer.

### Monthly cleaning of the brew group with "Coffee Oil Remover"



Besides weekly cleaning, we recommend running this cleaning cycle with the "Coffee Oil Remover" after approximately 500 cups of coffee or once a month. This operation completes the maintenance process of the brew group.

You can purchase separately the "Coffee Oil Remover". Please refer to the maintenance products page in this user manual for further details.



#### Caution:

**The "Coffee Oil Remover" tablets are to be used for cleaning only and do not have a descaling function. For the descaling procedure use the Saeco descaling solution and follow the procedure described in the "Descaling" chapter.**



- 1 Place a container under the dispensing spout.

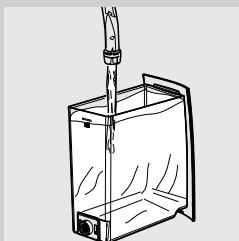

- 2 Make sure the water tank is filled with fresh water up to the "MAX" level.

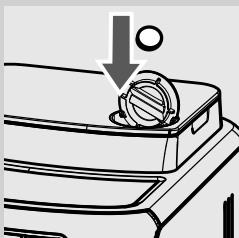

- 3 Put a "Coffee Oil Remover" tablet in the pre-ground coffee compartment.

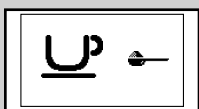

Green

- 4 Press the "☕" button one or more times to select the pre-ground coffee function. Do not add ground coffee

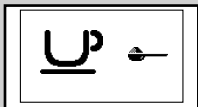
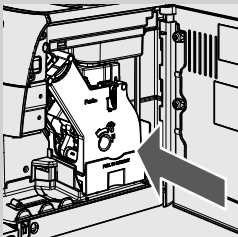
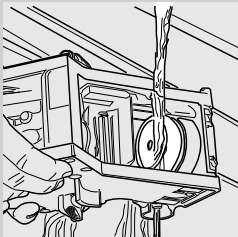
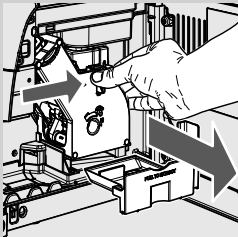

Green

- 5** Press the “☕  
MEMO” button to start a coffee brewing cycle.
- 6** Wait until the machine automatically ends the dispensing process.
- 7** Press the “⏻” button to turn off the machine, and let the solution take effect for approximately 15 minutes. Empty the container and put it back.
- 8** Turn on the machine and wait until the rinse cycle is completed.
- 9** Remove the coffee ground drawer and open the service door. Remove the coffee residues drawer and then the brew group.
- 10** Wash the brew group thoroughly with fresh water.
- 11** After rinsing the brew group, insert it again in its seat until it locks into place (see “Weekly cleaning of the brew group” chapter). Insert the coffee residues drawer and the coffee ground drawer. Close the service door.
- 12** Press the “☕  
MEMO” button to select the pre-ground coffee function. Do not add coffee to the pre-ground coffee department.
- 13** Press the “☕  
MEMO” button to start a coffee brewing cycle.
- 14** Repeat steps 12-13 twice. Empty the container.
- 15** To clean the drip tray, place “Coffee Oil Remover” tablet inside and fill it up to 2/3rds full with hot water. Let the cleaning solution take effect for about 30 minutes, then rinse thoroughly.

### Monthly cleaning of the coffee bean hopper

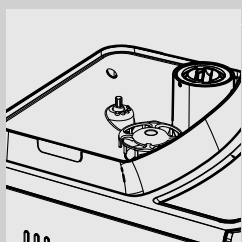

Clean the coffee bean hopper once a month when it is empty with a damp cloth to remove coffee oil. Thereafter refill it with coffee beans.

## DESCALING

The descaling process takes approx. 35 minutes.

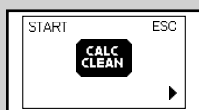

Yellow

Lime scale builds up inside the machine during use. It needs to be removed regularly as it may clog the water and coffee circuit of your machine. The machine tells you when descaling is needed. If the machine display shows the CALC CLEAN icon, it means that you need to descale.



#### Caution:

**Not doing this will ultimately make your machine stop working properly, and in this case repair is NOT covered by your warranty.**



Use the Saeco decalcifier only. Its formula has been designed to ensure better machine performance.

You can purchase separately the SAECO decalcifier. Please refer to the maintenance products page in this user manual for further details.



#### Warning:

**Never drink the decalcifier or any products dispensed until the cycle has been carried out to the end. Never use vinegar as a decalcifier.**



#### Note:

During the descaling cycle do not switch off the machine. If this has happened you need to restart the descaling cycle from the very beginning.

To execute the descaling cycle, follow the steps below:

Before descaling:

- 1 Empty the drip tray.

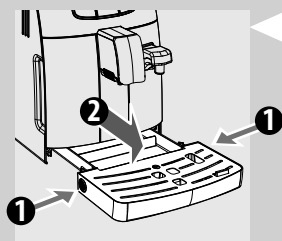



Yellow

- 2 Insert the milk carafe empty.
- 3 Remove the "INTENZA+" water filter from the water tank if it was installed.

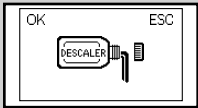

Red

- 4 Press the "MENU" button. Press the "☉" button until the following display is shown.
- 5 Press the "☉" button to enter the descaling menu.



**Note:**

If you press the "☉" button by mistake, press the "⏏" button to quit.

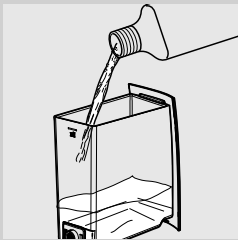

- 6 Remove the water tank and pour the entire content of the Saeco decalcifier. Then fill the water tank with fresh water up to the MAX level.

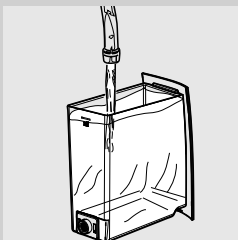

- 7 Place the water tank back into the machine.

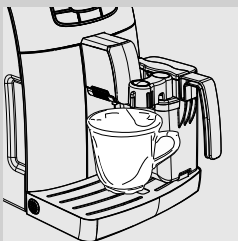

- 8 Place a large container (1,5 lt) under both the milk carafe dispenser and the dispensing spout.

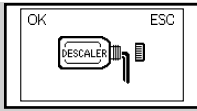

Red

**9** Press the “” button to start the descaling cycle.





Red

**10** The machine will start dispensing the descaling solution at intervals. The bar on the display shows the cycle progress.



Red

 **Note:**

The descaling cycle may be paused by pressing the “” button. To resume the cycle, press the “” button again. This allows you to empty the container or to stay away from the machine for a brief period of time.



Red

**11** When this icon is displayed, the water tank is empty.

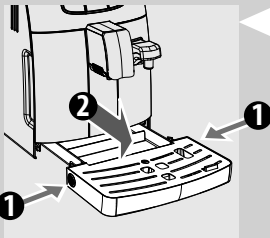

**12** Remove and empty the container and the milk carafe.

**13** Empty the drip tray and place it back.

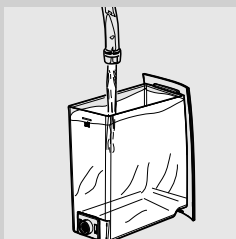

**14** Remove the water tank, rinse it and fill it up to the MAX level with fresh water. Place it back into the machine.

**15** Install the milk carafe into the machine. Place back the container under both the milk carafe dispenser and the dispensing spout.



Red

**16** When inserting the water tank into the machine, this icon is displayed. Press the “” button to start the rinsing cycle.



Red

**17** When this icon is displayed, the water tank is empty. Repeat steps 13 – 17. Then continue to step 19.

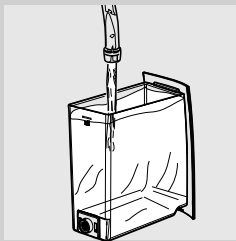

**18** When the water tank is empty, remove it from the machine. Rinse it and fill it up to the MAX level with fresh water. Place the water tank back into the machine.

**19** Remove and empty the container.

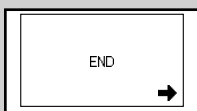

Red

**20** When the amount of water needed for the rinse cycle has been completely dispensed, this icon on the side is displayed. Press the “” button to quit the descaling cycle.



Yellow

**21** The machine automatically primes the circuit.

**22** The machine now carries out the warm-up and automatic rinse cycle to prepare for product brewing.

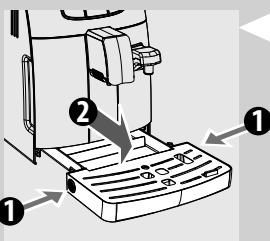

**23** Empty the drip tray and place it back.

**24** The descaling cycle is now completed.

- 25** Place back the "INTENZA+" water filter into the water tank if it was installed.

**Note:**

At the end of the descaling cycle, wash the brew group as described in the "Weekly cleaning of the brew group" chapter.

The two rinse cycles are performed in order to have the circuit cleaned with a preset amount of water to ensure proper machine performance. If the water tank is not filled up to MAX level, the machine might require three or more cycles.

**Note:**

It may happen that some liquid leaks on the milk carafe dispenser during descaling.

To reduce the leakage, proceed as follows:

- 1** Open the milk carafe dispenser by turning it counter-clockwise until it locks into place.

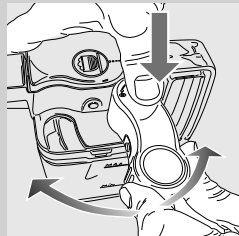
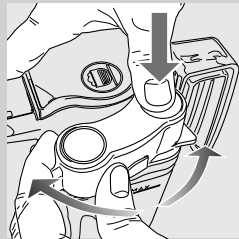
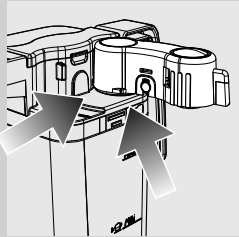

- 2** Press firmly the swivel and turn it by 45° for two or three times as shown in the pictures.



**PROGRAMMING**

You can change some of the machine operating settings according to her/his preferences.

**Adjustable parameters**

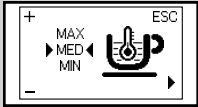

Yellow

**Coffee temperature**

This function allows you to adjust the coffee brewing temperature.

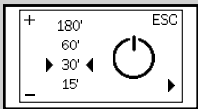

Yellow

**Timer (stand-by)**

This function allows you to adjust the time until the machine will go into standby mode after the last brewing.

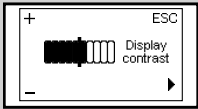

Yellow

**Contrast**

This function allows you to adjust the contrast of the display to better view the messages.



Yellow

**Water hardness**

This function allows you to adjust the water hardness setting according to the area where you live.

- 1 = very soft water
- 2 = soft water
- 3 = hard water
- 4 = very hard water

For more details please see the "Measuring and programming water hardness" chapter.

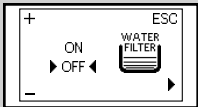

Yellow

**"INTENZA+" water filter**

This function allows you to manage the "INTENZA+" water filter. For more details, see the chapter related to filter handling.

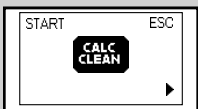

Yellow

**Descaling cycle**

This function allows you to run the descaling cycle.

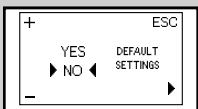

Yellow

**Factory settings**

This function allows you to reset all factory values.

**Programming mode example**

In this example, it is shown how to program the display contrast. Proceed in the same way to program the other functions.

The programming menu can only be accessed when the machine is on and shows this display.



Green

- 1 Press the "MENU" button to access programming

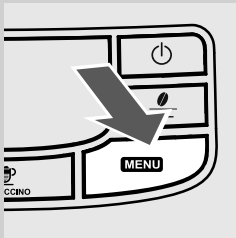

- 2 The first page is displayed.

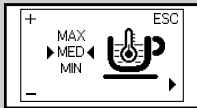

Yellow

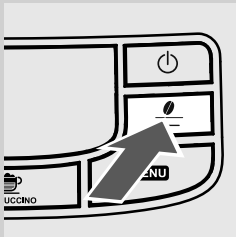

- 3 Press the "☕" button to scroll the functions pages until the display contrast function is displayed.

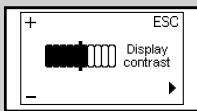

Yellow

- 4 Press the "☕ MEMO" and "☕ MEMO" buttons to increase or decrease the value of the function.

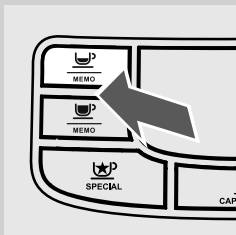

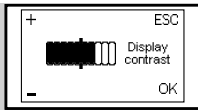

Yellow

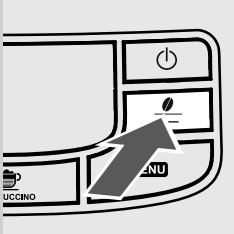

- 5 When the display value is changed, the "OK" message appears. Press the "OK" button to confirm the change.

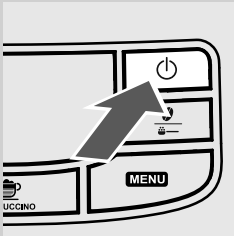

- 6 Press the "Power" button to exit the programming mode.

**Note:**

The machine will automatically exit the programming mode if you do not push any button for 3 minutes. The function's values that were changed but not confirmed won't be saved.

## MEANING OF THE DISPLAY SYMBOLS

This machine is equipped with a colour-coded system to make the user's understanding of the display signals easier. The icons are colour-coded according to the traffic light principle.

### Ready Signals (Green Colour)

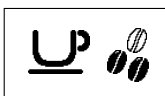

The machine is ready to brew products.

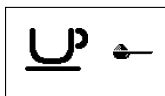

The machine is ready to brew pre-ground coffee.



Hot milk or hot water selection.

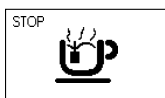

Hot water dispensing.

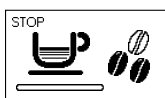

The machine is brewing one cup of espresso .

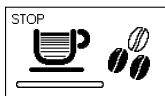

The machine is brewing one cup of coffee



The machine is brewing two cups of espresso.



The machine is brewing two cups of coffee



Hot milk dispensing.

**Ready Signals (Green Colour)**

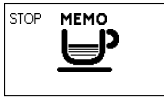

The machine is programming the amount of coffee to be brewed.

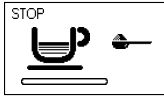

Coffee brewing using pre-ground coffee in progress.



The machine is brewing cappuccino.

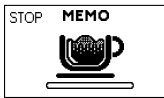

The machine is programming the amount of milk to dispense for the cappuccino.



The machine is programming the amount of coffee to dispense for the cappuccino.

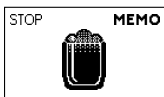

The machine is programming the amount of milk to dispense for the hot milk

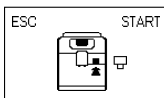

Insert the water dispenser and press "⏻" button to start dispensing.  
Press "☺" to exit.

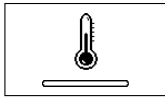
**Warning Signals (Yellow Colour)**

The machine is heating-up to brew beverages or dispense hot water.

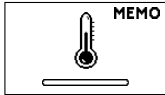

The machine is heating-up during beverages programming.



The machine performs the rinsing cycle. Wait until the machine has completed the cycle.

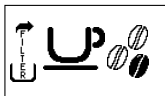

The machine needs the "INTENZA+" water filter to be replaced.



The brew group is being reset due to machine reset.

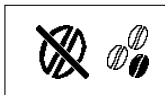

Refill the coffee bean hopper with coffee beans and restart the cycle.

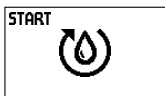

Prime the circuit.



The machine needs to be descaled. Press the "MEMO" button to enter the descaling menu. Follow the steps described in the "Descaling" chapter of this manual.

If you want to descale later, press the "⏻" button to continue using the machine.

Please note that not descaling your machine will ultimately make it stop working properly. In this case repair is NOT covered under your warranty.

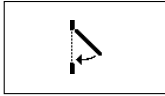
**Warning Signals (Red Colour)**

Close the service door.



Fill the coffee beans hopper.



The brew group must be inserted into the machine.

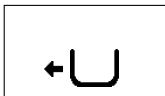

Insert the coffee ground drawer.

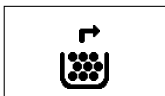

Empty the coffee grounds drawer and the coffee residues drawer.

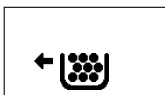

Fully insert the coffee ground drawer before turning the machine off.



Fill the water tank.



Insert drip tray.

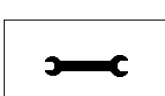

Turn off the machine. After 30 seconds, turn it on again. Try this 2 or 3 times. If the machine does not start, contact the Philips SAECO hotline in your country. You can find its contact details in the warranty booklet by-packed separately or on [www.philips.com/support](http://www.philips.com/support).

## TROUBLESHOOTING

This chapter summarizes the most common problems you could encounter with your machine. If you are unable to solve the problem with the information below, visit [www.philips.com/support](http://www.philips.com/support) for a list of frequently asked questions or contact the Philips Saeco hotline in your country. You find its contact details in the warranty booklet by-packed separately or on [www.philips.com/support](http://www.philips.com/support).

Machine actions	Causes	Solutions
The machine does not switch on.	The machine is not connected to the electric network.	Connect the machine to the electric network.
	The power button is set on "0".	Check that the power button is set to "I".
The drip tray gets filled although no water is drained.	Sometimes water is drained automatically by the machine into the drip tray in order to manage the rinsing of the circuits and ensure optimum machine performance.	This is conceived as a normal function in standard machine operation.
The red  symbol is always displayed on the machine.	The coffee grounds drawer has been emptied with the machine off.	The coffee grounds drawer must always be emptied with the machine on. Wait until the  symbol is displayed before refitting the drawer.
Coffee is not hot enough.	The cups are cold.	Preheat the cups with hot water.
No hot water is dispensed.	The hot water dispensing spout orifice is clogged.	Unclog the orifice of the hot water dispensing spout with a pin. <b>Make sure that the machine is off and cold before performing this operation.</b>
Coffee has not enough crema. (See note)	The blend is unsuitable, coffee is not freshly roasted or the grind is too coarse.	Change coffee blend or adjust the grind as explained in chapter "Adjusting the ceramic coffee grinder".
The milk was not frothed.	The milk carafe is dirty or not inserted correctly.	Verify the correct cleaning of the carafe and its insertion.
The machine takes a long time to warm up or the amount of water dispensed from the wand is too little.	The machine circuit is clogged by limescale.	Descale the machine.
The brew group cannot be removed.	The brew group is out of place.	Turn the machine on. Close the service door. The brew group automatically returns to the initial position.
	The coffee grounds drawer is inserted.	Remove the coffee grounds drawer before removing the brew group.
There is a lot of ground coffee under the brew group.	Coffee is not suitable for automatic machines.	It may be necessary to change the type of coffee or the coffee grinder settings.



Machine actions	Causes	Solutions
The machine grinds the coffee beans but no coffee comes out. (See note)	There is no water.	Fill the water tank and prime the circuit (chapter "Using the Machine for the First Time").
	The brew group is dirty.	Clean the Brew Group ("brew group" chapter).
	This might occur when the machine is automatically adjusting the dose.	Brew a few coffees as described in chapter "Saeco Adapting System".
	The dispensing spout is dirty.	Clean the dispensing spout.
Coffee is too weak. (See note)	This might occur when the machine is automatically adjusting the dose.	Brew a few coffees as described in chapter "Saeco Adapting System".
	The coffee is too coarse.	Change coffee blend or adjust the grind as explained in chapter "Adjusting the Coffee Grinder".
Coffee is brewed slowly. (See note)	The coffee grind is too fine.	Change coffee blend or adjust the grind as explained in chapter "Adjusting the ceramic coffee grinder".
	Circuits are clogged	Perform a descaling cycle.
	The brew group is dirty.	Clean the brew group ("Weekly cleaning of the brew group" chapter).
Coffee leaks out of the dispensing spout.	The dispensing spout is clogged.	Clean the dispensing spout and its holes.

**Note:**

These problems can be considered normal if the coffee blend has been changed or if the machine has just been installed. In this case wait until the machine performs a self-adjusting operation as described in chapter "Saeco Adapting System".

## ENERGY SAVING

### Stand-by



Black

The Saeco full automatic espresso machine is designed for energy saving-proven by the Class A energy label.

After 30 minutes of inactivity, the machine turns off automatically. If a product has been brewed, the machine performs a rinsing cycle.

In stand-by mode, the energy consumption is below 1Wh. To turn on the machine, press "⏻" button (if power button on the back of the machine is set to "I"). If the boiler is cold the machine performs a rinsing cycle.

### Disposal



Do not throw away the machine with the normal household waste at the end of its life, but hand it in at an official collection point for recycling. By doing this, you help to preserve the environment.

- The packing materials can be recycled.
- Machine: unplug the machine and cut the power cord
- Deliver the appliance and power cord to a service center or public waste disposal facility.

This product complies with EU directive 2002/96/EC.

The symbol on the product or on its packaging indicates that this product may not be treated as household waste.

Instead it shall be handed over to the applicable collection point for the recycling of electrical and electronic equipment.

By ensuring this product is disposed of correctly, you will help prevent potential negative consequences for the environment and human health, which could otherwise be caused by inappropriate waste handling of this product. For more detailed information about recycling of this product, please contact your local city office, your household waste disposal service or the shop where you purchased the product.

## TECHNICAL SPECIFICATION

The manufacturer reserves the right to make changes to the technical specifications of the product

Nominal Voltage - Power Rating - Power Supply	See label on the inside of the service door
Housing material	ABS - Thermoplastic
Size (w x h x d)	256 x 340 x 440 cm
Weight	9 kg
Power Cord Length	1.2 m
Control Panel	Front
Size of cup	110
Water Tank	1.5 liters –Removable type
Coffee Bean Hopper Capacity	300 gr
Coffee ground drawer capacity	10
Pump pressure	15 bar
Boiler	Stainless steel
Safety mechanisms	Thermal fuse
Safety mechanisms	Thermal fuse

## GUARANTEE AND SERVICE

### Guarantee

For detailed information on your warranty and related conditions, please read the warranty booklet by-packed separately.

### Service

We want to ensure that you remain satisfied with your machine. If not done already, please register your product on [www.philips.com/welcome](http://www.philips.com/welcome) so that we can stay in contact with you and send you cleaning and descaling reminders.

If you need service or support, please visit the Philips website at [www.philips.com/support](http://www.philips.com/support) or contact the Philips Saeco hotline in your country. You find its phone number in the warranty booklet by packed separately or on [www.philips.com/support](http://www.philips.com/support).

## ORDERING MAINTENANCE PRODUCTS

For cleaning and descaling, use Saeco maintenance products only. You can purchase these at the Philips online shop at [www.shop.philips.com/service](http://www.shop.philips.com/service), your local dealer or at authorised service centers.

If you have any difficulties obtaining maintenance products for your machine, please contact the Philips Saeco hotline in your country.

You find its contact details in the warranty booklet by-packed separately or on [www.philips.com/support](http://www.philips.com/support).

Overview of maintenance products



- Decalcifier CA6700



- INTENZA+ Water Filter CA6702

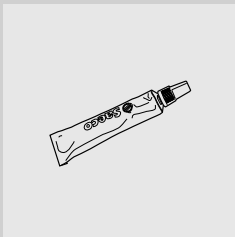

- Grease HD5061



- Coffee Oil Remover CA6704

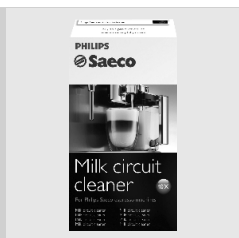

- Milk Circuit Cleaner: CA6705



- Maintenance Kit CA 6706

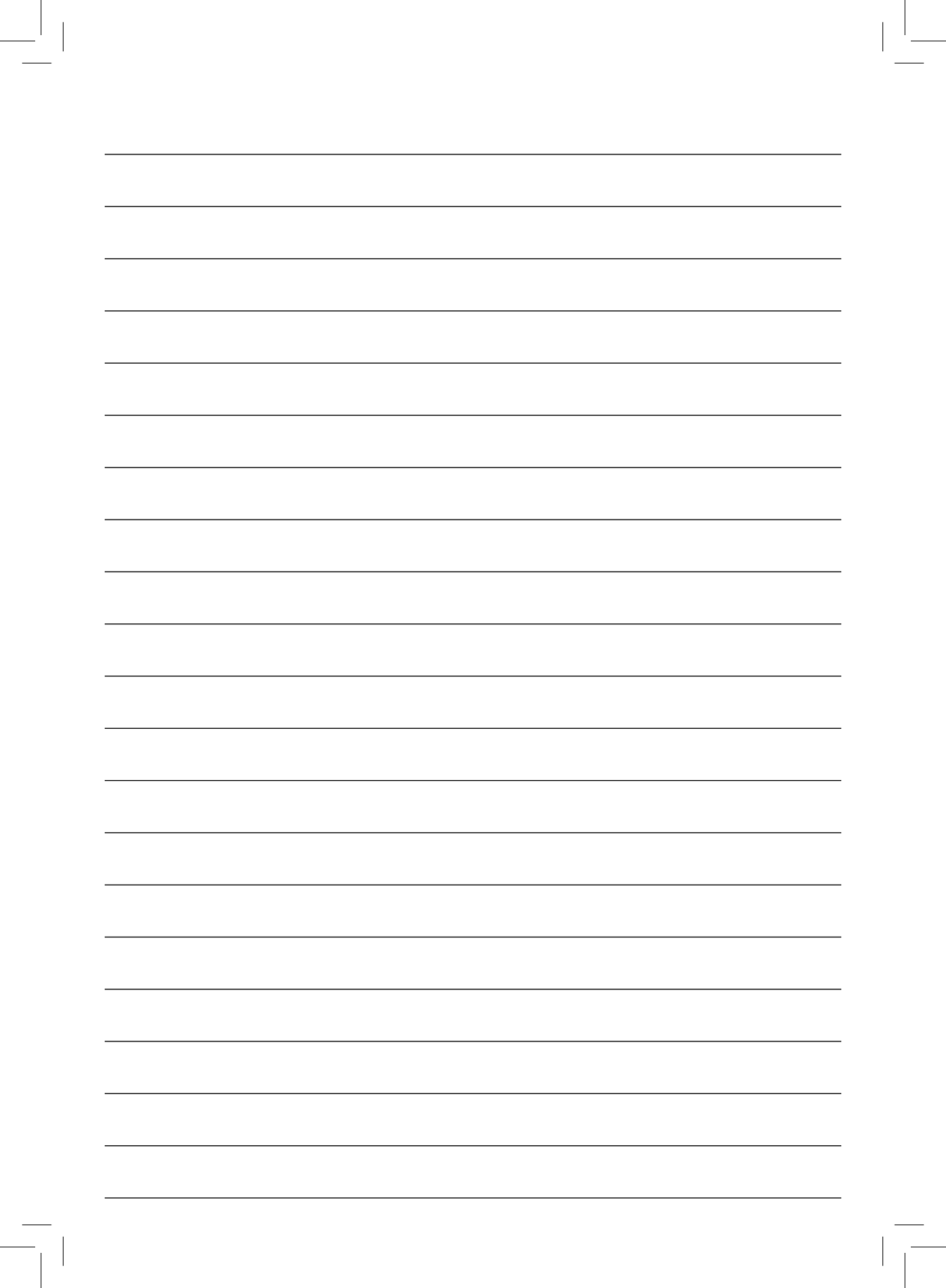



02



The manufacturer reserves the right to make changes without prior notice.

[www.philips.com/saeco](http://www.philips.com/saeco)



421940425321

Rev.06 del 15-02-13

02

EN