

Register Now

www.delonghi.photo



www.delonghi.com



5713245311_01_0819 printed in China

ICM17 series

COFFEE MAKER
MACHINE À CAFÉ
CAFETERA

ELECTRIC CHARACTERISTICS
CARACTÉRISTIQUES ÉLECTRIQUES
CARACTERISTICAS ELECTRICAS:

120V~ 60 Hz 1200 Watts



DeLonghi

EN

page 6

FR

page 9

ES

pág. 12

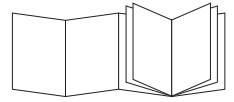

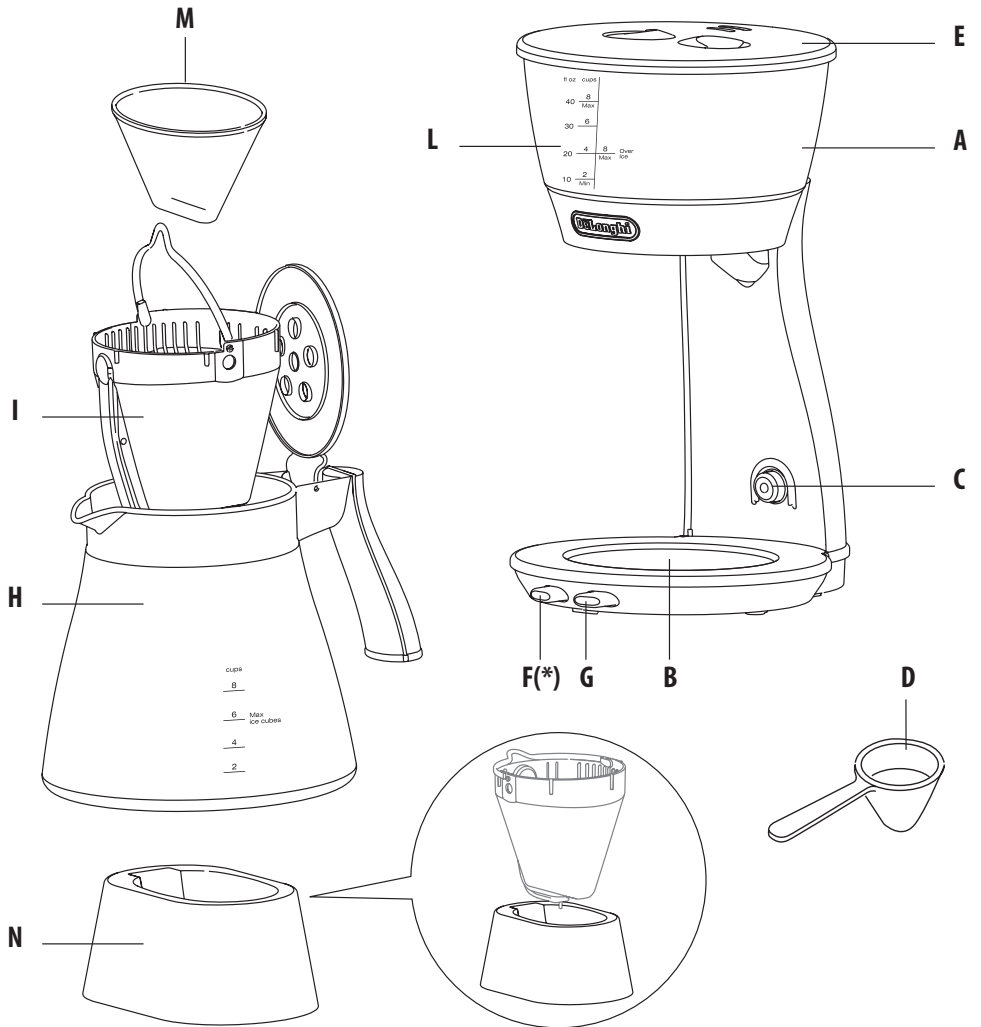

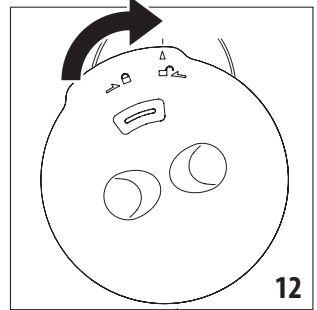
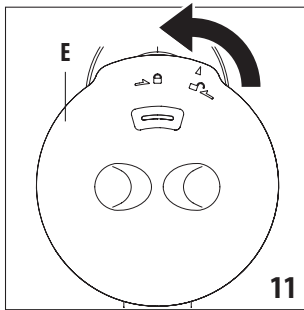
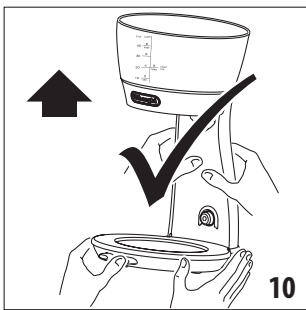
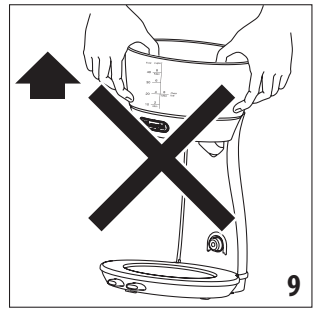
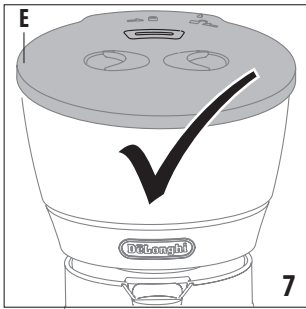
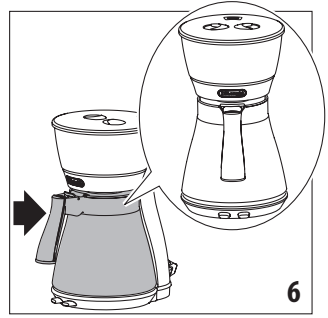
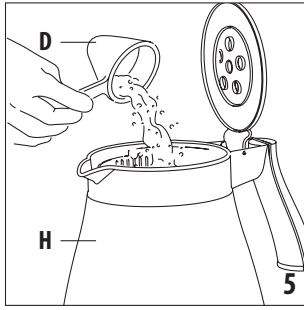
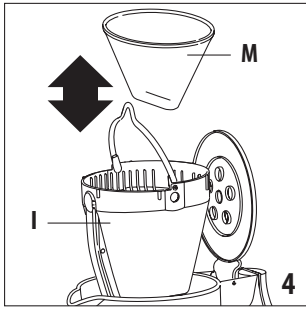
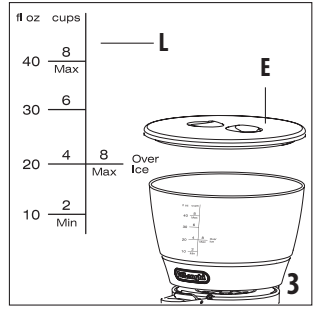
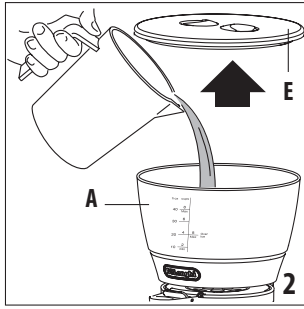
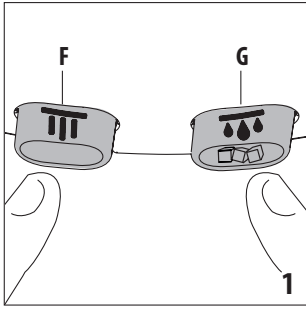

IMPORTANT SAFEGUARDS

When using any electrical appliance, some basic safety precautions should be observed. Specifically:

- Read all instructions carefully.
- Make sure the voltage of your electrical system corresponds to the voltage shown on the bottom of the machine.
- Do not touch hot surfaces. Use handles or knobs.
- To protect against fire, electrical shock and personal injury, do not immerse cord, plug, or appliance in water or other liquid.
- Keep the appliance out of the reach of children and do not leave appliance unattended while in operation.
- Disconnect the plug from the power outlet when the machine is not in use and before cleaning.
- Do not operate the machine with a damaged cord or plug, after faulty operation, or when it has been damaged in any way. Contact De'Longhi Customer Service.
- The use of accessories not recommended by the manufacturer may result in fire, electrical shock, or personal injury.
- Do not use the machine outdoors.
- Make sure the power cord does not hang over the edge of the table or counter-top to avoid getting accidentally caught or entangled.
- Do not place the machine or its electrical parts on or near electric stoves, cooking surfaces, or gas burners.
- To disconnect the appliance, turn appliance "OFF", then remove plug from wall outlet.
- Do not use this machine for any purpose other than its intended use. This appliance is for household use only. The manufacturer declines all responsibility for any damage caused by improper, incorrect, or irresponsible use.
- For machines with glass carafe:
 - A. The carafe is an accessory to be used exclusively with this appliance. Never use it on a cooking surface.
 - B. Do not set the hot container on a damp or cold surface.
 - C. Do not use the carafe if it is cracked or the handle is not completely sturdy.
 - D. Do not use abrasive detergents or sponges to clean.
 - E. Scalding may occur if the lid is opened during the brewing cycles.

WARNING: To prevent the risk of fire or electric shock, never remove the lower part of the appliance. There are no elements inside that the user needs to access. Any necessary repairs must be made by an authorized service center.

SAVE THESE INSTRUCTIONS

THIS APPLIANCE IS FOR HOUSEHOLD USE ONLY

DESCRIPTION OF APPLIANCE

- A. Water Tank
 - B. Warming Plate
 - C. Carafe Sensor
 - D. Measuring Scoop
 - E. Lid
 - F. SCA Golden Cup Button
 - G. Over-ice and pour over brew button
 - H. Glass Carafe
 - I. Filter holder
 - L. Water level indicator
 - M. Paper Filter Cone Size #4
 - N. Filter holder base
- (*) This model has been certified by the (SCA) Specialty Coffee Association to meet their rigorous technical requirements when using the Golden Cup Function (F)

FIRST USE

In order to prime the machine for first time use you will need to perform two full brewing cycles, without coffee, using fresh, cold water only, as follows:

- Plug into outlet
- Turn the lid counter-clockwise to unlock lid and remove (fig. 11).
- Pour fresh water into water tank up to the MAX level (40 oz.) (fig. 2-3).
- Put the LID and turn clockwise to lock in (fig. 12).
- Push the SCA Golden Cup button (F) to prime the machine.
- At the end empty the carafe and do again the cycle.

SPECIALTY COFFEE ASSOCIATION (SCA) GOLDEN CUP STANDARDS

Requirements for SCA Certified Home Brewers:

- Infusion temperature 197.5 - 204.8°F (92-96°C)
- Saturation time (4 to 8 minutes)
- Coffee to Water Ratio 1 measuring scoop (8.25 g) per Cup (5 oz.)

The De'Longhi 3 in 1 Specialty Brewer meets these requirements and has earned the certifications of the Specialty Coffee Association (SCA).

SCA GOLDEN CUP FUNCTION

Thanks to a high precision brewing technology De'Longhi 3 in 1 Specialty Brewer provides optimum flavor extraction and has earned the approval from the Specialty Coffee Association (SCA): brewing filter coffee with a precise temperature 197.5 - 204.8°F (92°C - 96°C) and infusion time control, for a perfect and tasty coffee cup after cup.

POUR OVER BREWING FUNCTION

A specifically designed shower head and automatic waterflow control, ensures an evenly saturated coffee powder for a more intense and aromatic flavour, at the touch of a button.

OVER ICE BREWING FUNCTION

Our SCA certified machine delivers bold, rich taste that is never watered down, even over ice.

HOW TO MAKE SCA GOLDEN CUP COFFEE OR POUR OVER

When using this function it is recommended to use the coffee to water ratio of 1 measuring scoop per cup.

- To remove the lid, turn counterclockwise to unlock (fig. 11). Pour fresh water into the water tank (A) (fig. 2) up to the level indicated for the number of cups of coffee you want to make (L) (fig. 3).
- Position the paper filter (M) in the filter holder (I) (fig. 4). Use only paper cone filter #4.
- Place the ground coffee in the filter using the measuring scoop (D) provided and level evenly (fig. 5). See the table for recommended quantities. Use high quality ground coffee for drip coffee makers.

Recommended quantities:

No. cups	No. measuring scoop (*)
8	8
6	6
4	4
2	2

1 measuring scoop = 0.3 oz. (8.25 g)

The quantities given in the table are suggested and should be adapted to your personal taste and the type of coffee. The type of blend has a considerable influence on the coffee you make. You should therefore try various types of coffee to find the one best suited to your taste.

- To lock the lid align the symbol  with the indicator line on the back of the machine (fig. 12). Then turn the lid clockwise to lock in place, aligning the lock symbol with indicator line on the back of the machine.
- Make sure the carafe is correctly placed on the warming plate.
- To select SCA Golden Cup function push button (F)
- To select Pour Over function push button (G) twice quickly
- Once you have selected your desired coffee function there will be one beep sound and the corresponding button will light up. When the brewing cycle ends there will be three

beeps.

- To stop the brewing cycle before completion, push the illuminated button once.
- Please note, throughout the brewing cycle it is normal for steam to be released.

HOW TO MAKE OVER ICE COFFEE

- Fill carafe with ice cubes up to the max indicated on the carafe.
- Pour four cups of water into the water tank and eight measuring scoops of ground coffee into filter to produce 8 cups of Over Ice Coffee. Do not exceed these recommended quantities.
- To select Over Ice function press button (G). Once the Over Ice function has been activated there will be one beep sound and a blue light will be illuminated on the button.
- To stop the brewing cycle before completion, push the illuminated button.

 **Please note:** Before pouring coffee from the carafe, remove the filter holder and place it on the filter base (N).

ANTI-DRIP SYSTEM

This coffee maker has an automatic anti-drip system, Carafe Sensor (C), that stops brewing when the glass carafe has been removed from the warming plate. To continue the brewing cycle place the carafe back onto the warming plate.

WARMING PLATE

Once the brewing cycle has finished, the warming plate will stay on for one hour in order to keep the coffee at the ideal temperature.

If you want to turn off the warming plate before one hour, then push the illuminated button (F or G).

 **Please note:** When using the Over Ice function the warming plate will automatically turn off and remain off.

CLEANING AND MAINTENANCE

Before maintenance or cleaning of the appliance, turn off, unplug and allow to cool.

- Do not use solvents or abrasive detergents to clean the coffee maker. Just wipe with a soft damp cloth.
- Never immerse the coffee maker in water. It is an electrical appliance.
- The water fill compartment (A) can be reached through the lid (E). Clean when necessary.
- Do not wash the jug and accessories in the dishwasher.

DESCALING

If the water in your area is hard, limescale builds up over time. These deposits may affect correct operation of the appliance. You are recommended to descale the coffeemaker when two buttons (F) and (G) flash simultaneously, which is approximately every 60 cycles. If limescale visibly builds up in the water tank prior to the buttons flashing and you would like to activate the descaling process yourself, you will need to push and hold both buttons (F & G) simultaneously for 2 seconds.

- To descale, always use De'Longhi descaler available at Delonghi.com.
- Pour 3.4 oz (100 ml) De'Longhi descaler in the water tank and add fresh water up to 8 cup (max) level.
- Place the empty carafe on the warming plate and hold for 2 seconds both the buttons (F & G) simultaneously. The descaling process will begin.
- Once the descaling cycle is complete the lights on the two buttons will turn off. Rinse the machine by following the instructions in the "First Use" section on page 6.
- Failure to clean as described above invalidates the Warranty.

TECHNICAL DATA

Mains voltage:	120V ~ 60Hz
Absorbed power: ICM17270	1200W
Weight:	5.38 lbs

TROUBLESHOOTING

Problem	Probable cause	Solution
Continuous blinking of SCA Golden Cup light button (F)	Empty tank error	To reset the alarm unplug the appliance for at least 30 minutes.
Water overflowing from filter holder to the carafe	Ground Coffee is too fine or too much	Use a coarser grind size or reduce the amount of coffee used
Coffee residue in the carafe	Ground coffee is too fine or there is too much, or missing paper filter	Use a coarser grind size or reduce the amount of coffee used. Always use a # 4 cone filter inside the filter holder.