



Impressa S9 One Touch



Impressa S9 One Touch

Fully Automatic
Coffee & Espresso Center
with Clearyl Water Care System

Operating Instructions
and Warranty

Customer Service 1-800-220-5701

IMPORTANT SAFEGUARDS

When using electrical appliances, basic safety precautions should always be followed, including the following:

1. Read all instructions.
2. Do not touch hot surfaces. Use handles or knobs.
3. To protect against fire, electric shock and personal injury, do not immerse cord, plugs or appliance in water or other liquids.
4. Close supervision is necessary when any appliance is used by or near children.
5. Unplug from outlet when not in use and before cleaning. Allow it to cool before putting on or taking off parts, and before cleaning the appliance.
6. Do not operate any appliance with a damaged cord or plug or after the appliance malfunctions, or has been damaged in any manner. Return appliance to the nearest authorized service facility for examination, repair or adjustment.
7. The use of accessory attachments not recommended by the appliance manufacturer may result in fire, electric shock, or personal injury.
8. Do not use outdoors.
9. Do not let the cord hang over the edge of a table or counter, or touch hot surfaces.
10. Do not place on or near a hot gas or electric burner, or in a heated oven.
11. Always attach plug to appliance first, then plug cord into

wall outlet. To disconnect, turn any control to “off” then remove plug from wall outlet.

12. Do not use appliance for other than intended use.
13. Use extreme caution when disposing hot steam.
14. For household use only.

SAVE THESE INSTRUCTIONS SPECIAL CORD SET INSTRUCTIONS

Regarding your cord set:

- A. A short power-supply cord (or detachable power-supply cord) is to be provided to reduce risks resulting from becoming entangled in or tripping over a longer cord.
- B. Longer detachable power-supply or extension cords are available and may be used if care is exercised in their use.
- C. If a long detachable power-supply cord or extension cord is used,
 - 1) The marked electrical rating of the detachable power supply cord or extension cord should be at least as great as the electrical rating of the appliance,
 - 2) If the appliance is of the grounded type, the extension cord should be a rounding type 3-wire cord, and
 - 3) The longer cord should be arranged so that it will not drape over the counter-top or table-top where it can be pulled on by children or tripped over.

Notice: This machine has a 3-prong grounded plug. To reduce the risk of electrical shock, this plug will fit in an outlet only one way. If the plug does not fit in the outlet, contact a qualified electrician. DO NOT modify the plug in any way.

CAUTION

This appliance is for household use. Any servicing other than cleaning and user maintenance should be performed by an authorized service representative.

- Do not immerse base in water or try to disassemble.
- To reduce the risk of fire or electric shock, do not remove the base. No user serviceable parts inside. Repair should be done by authorized service personnel only.
- Check voltage to be sure that the voltage indicated on the name plate agrees with your voltage.
- Never use warm or hot water to fill the water container! Use cold water only!
- Keep your hands and the cord away from hot parts of the appliance during operation.
- Never clean with scouring powders or hard implements.

JURA-CAPRESSO

Jura was founded in 1931 in Switzerland. Capresso was founded in 1994 in the USA. Both companies have joined forces in the US to bring you the finest Fully Automatic Coffee Centers available anywhere. With innovative and user-friendly features, high quality materials, clear instructions and superb customer service, we are sure you will experience the best coffee, espresso, cappuccino or latte you have ever had. We hope you will enjoy your new Fully Automatic Coffee Center and will recommend it to your friends. For more information about our products visit our website www.capresso.com.

Customer Service

1-800-220-5701

Mon-Thu 9AM – 9PM • Fri 9AM – 8PM • Sat 9AM – 5PM
Eastern Standard Time.
email: contact@capresso.com

Jura-Capresso

81 Ruckman Road, Closter, NJ 07624
201-767-3999 • Fax: 201-767-9684
Website: www.capresso.com

FIG. 1

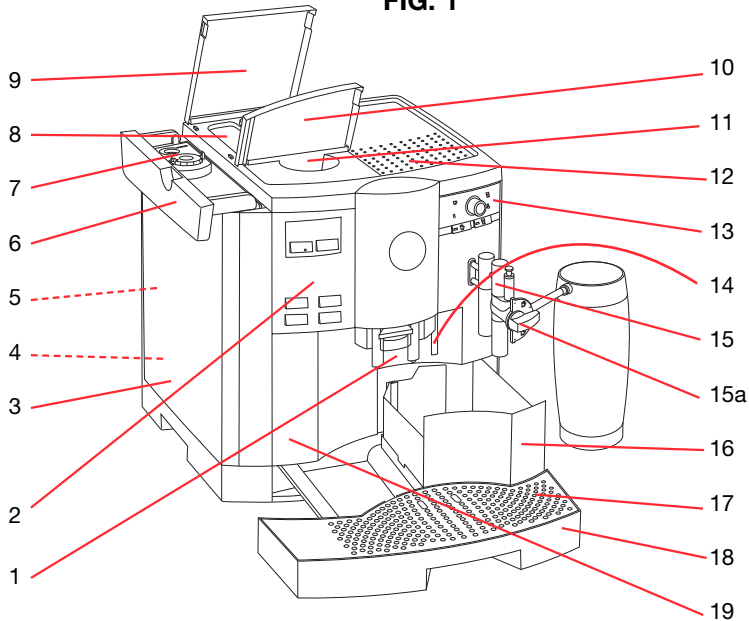

1. Height-Adjustable Dual Coffee Spout
2. Operating Display (Fig.2)
3. Removable Water Tank
4. Low Water Flotation Device (inside)
5. Clearyl Water Care Cartridge (Not Installed)
6. Lid for Water Tank
7. Holder for Clearyl Water Cartridge
8. Bean Aroma Protection Lid
9. Cover for Bean Container
10. Lid for Ground Coffee Funnel
11. Opening for Ground Coffee
12. Warming Plate
13. Auto Cappuccino System (Fig. 3)
14. Hot Water Spout
15. Steam Nozzle
- 15a. frothXpress system (Fig. 15 through 17a) with thermal milk container attached
16. Used Coffee Container
17. Cup platform
18. Removable Drawer/Used Water Tray
19. Cover for Rotary Dial and A La Carte Button (Fig. 3A)

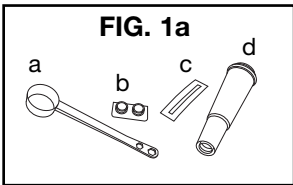

- a. Scoop
- b. Cleaning tablets
- c. Water indicator
- d. Clearyl filter

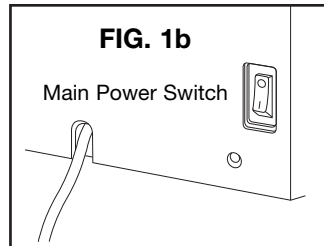

Operating Display

FIG. 2

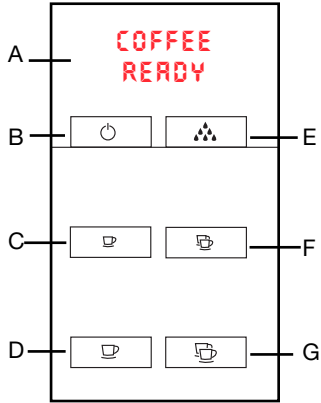

- A. Display Dialog System
- B. **ON/OFF** Button
- C. **1-CUP Espresso** Button
- D. **1-CUP Coffee** Button
- E. **RINSE** Button
- F. **2-CUP Espresso** Button
- G. **2-CUP Coffee** Button

Auto Cappuccino System

FIG. 3

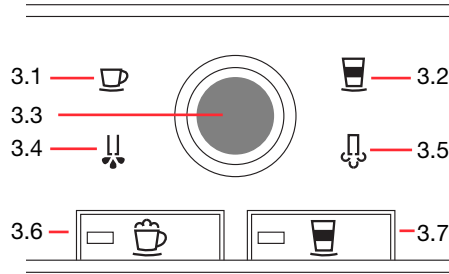

- 3.1 Hot Water Portion symbol
- 3.2 Milk Portion symbol
- 3.3 **Selector Dial** with push button
- 3.4 Hot Water symbol
- 3.5 Milk symbol
- 3.6 **Cappuccino** button
- 3.7 **Latte Macchiato** button

FIG. 3A

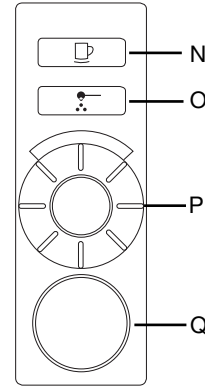

- N. **A La Carte** Button
- O. **Ground Coffee** Button
- P. **Rotary Dial** w/push button
- Q. **Service Cover**
(do not remove)

FIG. 4

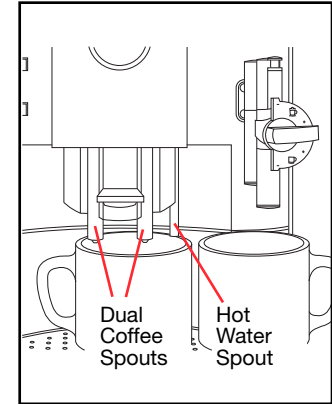

FIG. 5

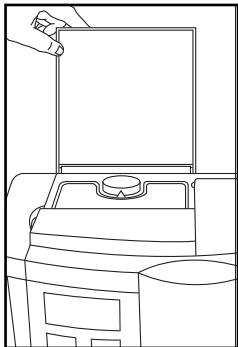

FIG. 6

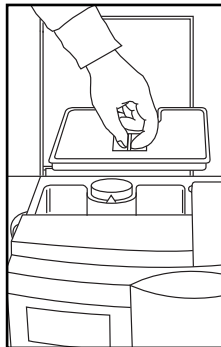

FIG. 7

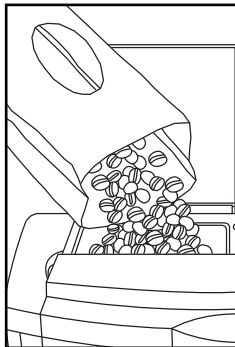

FIG. 8

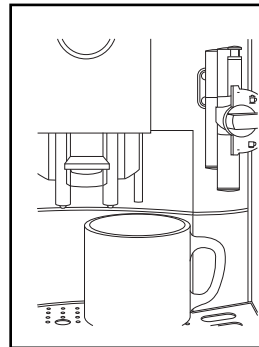

FIG. 9

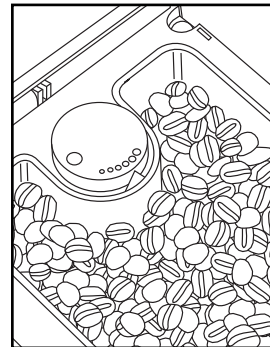

FIG. 10

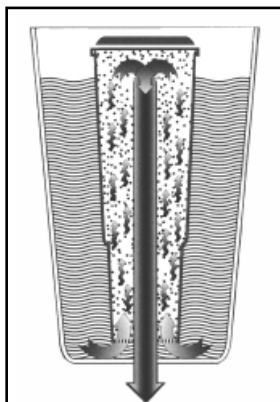

FIG. 11

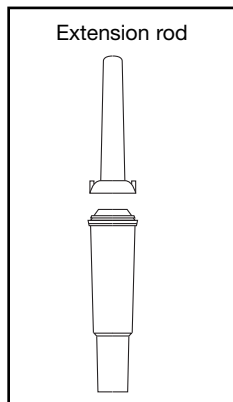

FIG. 12

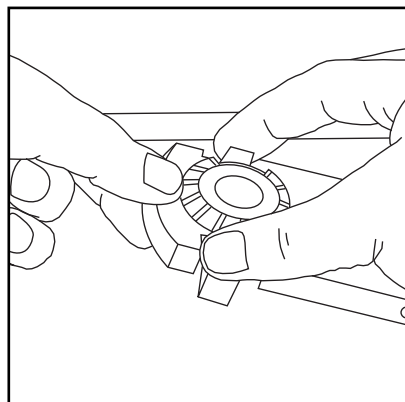

FIG. 13

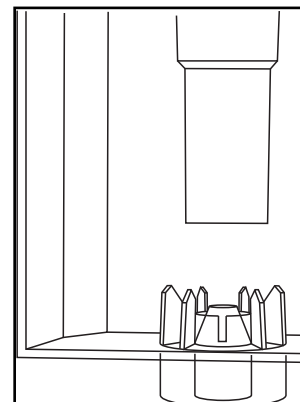

FIG. 14a

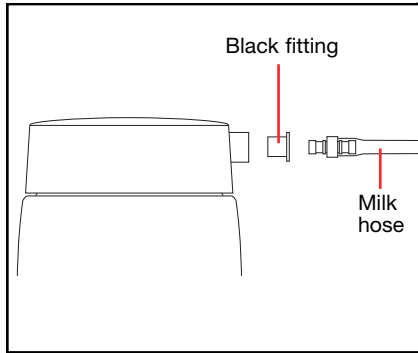

FIG. 14b

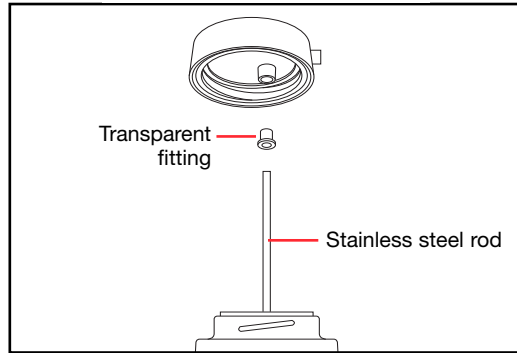

FIG. 15

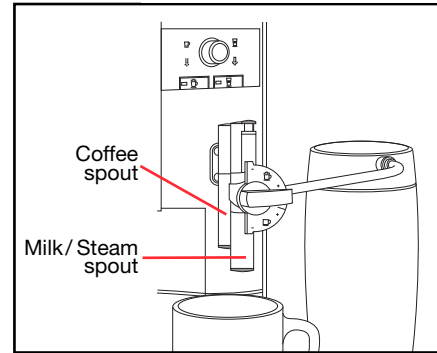

FIG. 16

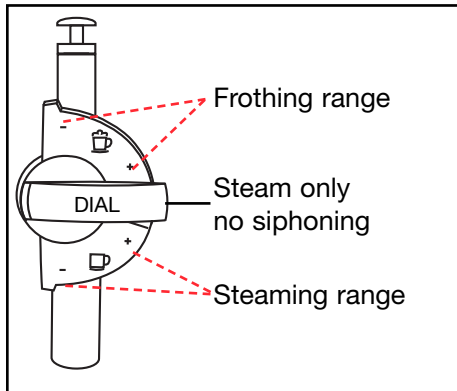

FIG. 17

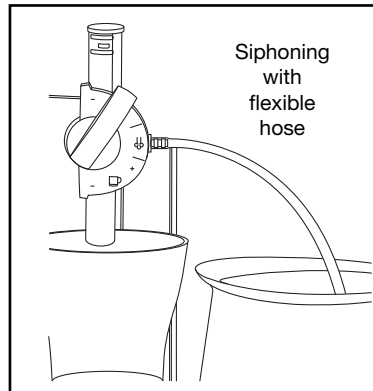

FIG. 17a

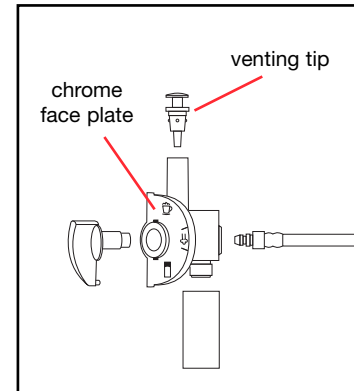

FIG. 18



FIG. 19

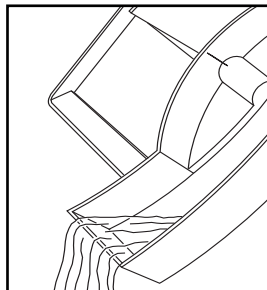

FIG. 20

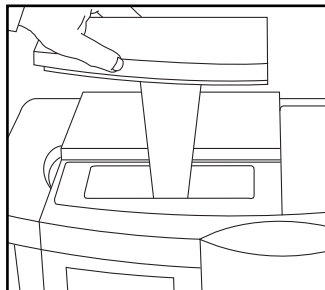

FIG. 21

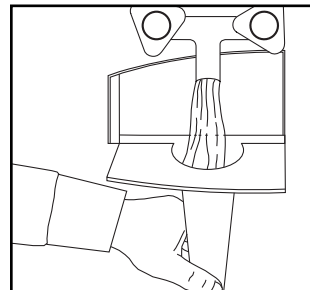

FIG. 22

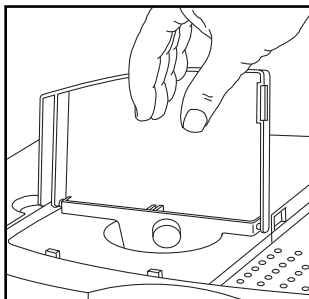

FIG. 23

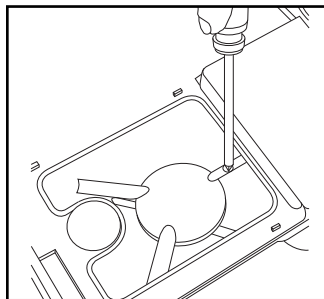

FIG. 24

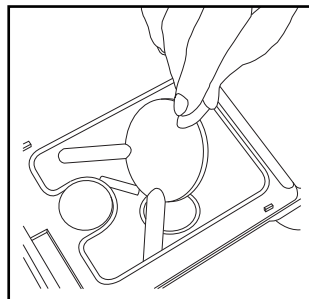

FIG. 25

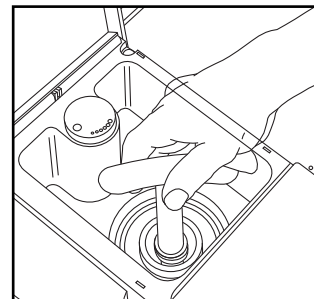

TABLE OF CONTENTS

	PAGE		PAGE
Important Safeguards / Jura Capresso	2	8a. Turning the Machine Off / Rinsing.....	16
Drawings	4-8	9. Coffee Preparation	16
Important / Battery Back-up	11	9a. Pre-warm Cups	16
1. Product Warranty Registration.....	11	9b. Brewing Coffee and Espresso	16
2. Operating Instructions / Quick Reference Guide	11	9c. Overriding Strength and Cup Size During Brewing	17
3. Welcome to the Impressa S9 One Touch.....	11	9d. The A La Carte Button.....	17
3a. Bean-to-cup, “Crema Coffee” and Pressure Brewing	12	9e. Using Pre-Ground Coffee	17
3b. Different Coffee Drinks.....	12	10. Auto Cappuccino System	18
3c. Coffee Facts.....	12	10a. Preparing the Thermal Milk Container.....	18
4. Please Don’t / Please Do	12	10b. The Froth XPress System	18
5. Factory Settings / Options.....	13	10c. Preparing One-Touch Cappuccino, Cafe Mocha and Latte	19
6. Preparing the Machine for the First Time	14	10d. Preparing One-Touch Latte Machiato	19
6a. Filling the Water Tank.....	14	10e. Preparing Hot Milk / Hot Chocolate	19
6b. Filling the Bean Container	14	10f. Overriding the Cappuccino Settings	20
6c. Turning the Machine On for the First Time	15	10g. Cappuccino Rinsing.....	20
6d. Cup Illumination	15	10h. Using Hot Water.....	20
7. Adjusting the Grinder	15	11. Visual Programming of Beverage Portions	21
8. Daily Preparation.....	15	12. Water Care	21

TABLE OF CONTENTS Continued

	PAGE		PAGE
12a. Water Hardness Monitor	21	15. Care and Maintenance Messages	29
12b. Changing the Water Hardness Monitor	22	15.1 Manual Maintenance Cycles	30
13. Clearyl Water Filter Cartridge.....	22	15.2 Removing Stones etc. from the Burr Grinder	31
13a. Installing and Activating the Clearyl Water Cartridge	23	15.3 General Cleaning Instructions	31
13b. Automatic Clearyl Replacement.....	23	15.4 Emptying the System before Transport.....	31
13c. Manual Clearyl Replacement	24	15.5 Cleaning the frothXpress	31
13d. Do Not Let the Clearyl Filter Dry Out!.....	24	16. Automatic Cleaning Cycles	32
14. Programming	24	16.1 Cleaning with Special Tablet	32
14.1 Re-Programming Beverage Buttons	24	16.2 Manual Tablet Cleaning	33
14.2 Restoring Factory Settings for Beverage Buttons	26	17. Decalcifying.....	33
14.3 Economy Modes	26	17.1 Decalcifying Procedure.....	34
14.4 Actual Time and Weekday	27	17.2 Manual Decalcifying.....	34
14.5 Auto-On and Auto-Off Times.....	27	18. Tips For Better Coffee	35
14.6 Auto-Off.....	28	19. Error Messages / Troubleshooting.....	35
14.7 Rinse Settings.....	28	20. Supplies	36
14.8 Information	29	21. Limited Two-Year Warranty.....	37
14.9 Display Settings	29	22. Free Repair Service / Extra Repair Coverage	38
14.10 Languages.....	29		

IMPORTANT / BATTERY BACK-UP

The Impressa S9 One Touch has an internal battery back-up for the clock functions. After plugging the S9 OT in for the first time, turn the Main Power Switch in the back of the machine on (Fig. 1b; the red indicator light in the ON/OFF button (Fig. 2,B) will illuminate). Leave the main power switch on for the first 24 hours to insure that the internal battery back-up is fully charged.

1. PRODUCT WARRANTY REGISTRATION

Remove the Product Registration from the Welcome Pack, fill it out and mail or fax it to us within two weeks or register your product online through our website: www.cappresso.com.

Important: This registration is part of your warranty (chapter 21). If your retailer sent the product registration to Jura-Cappresso when you purchased the machine, it is not necessary to register again.

2. OPERATING INSTRUCTIONS

QUICK REFERENCE GUIDE / DVD

Thank you for choosing this Jura-Cappresso product.

Important: Do not try to set-up the Impressa S9 One Touch without following the set-up steps in chapter 6 - 8. Or use the Quick Reference Guide.

- Take time to study this instruction manual. It covers many features of the S9 OT and provides helpful hints and will enhance your enjoyment with coffee beverages.
- We highly recommend viewing the enclosed DVD.

3. WELCOME TO THE IMPRESSA S9 One Touch

This fully automatic coffee/espresso/cappuccino center is completely programmable and extremely user friendly. The S9 OT prepares a cup of cappuccino or latte at a push of a button

without moving your cup, brews one or two cups of crema coffee or espressos at a time, produces unlimited amounts of hot frothed and hot steamed milk and delivers up to 15 oz. hot water – all with a push of a button.

With its two independent stainless steel Thermoblock heating systems it switches from brewing coffee to frothing milk without any up- or down-time. The two-step pressure brewing system - well known in commercial applications - was adapted and refined by Jura coffee specialists and is the trademark of each Jura-Cappresso coffee center. This two step brewing system ensures optimal coffee extraction and will finish every cup with a rich layer of "crema" - proof for perfectly pressure brewed coffee. The adjustable, commercial conical burr grinder grinds beans to the desired fineness (6 settings). Use pre-ground coffee with the separate filler funnel. The second Thermoblock generates unlimited steam instantly. Program a specific amount of frothed/steamed milk and the S9 OT will always deliver your preferred cup size. A separate hot water spout prepares a cup of tea or any other hot beverage in seconds. With four pre-set coffee buttons, four pre-set milk beverage buttons, a special A La Carte button and the easy-to-use Rotary Dial you can prepare thousands of different coffee beverages with the push of a button. Override or re-program your favorite coffee drinks. Select from different maintenance set-ups. The S9 OT automatically reminds you when to refill water, clean, change filter or decalcify. The "Information" section lets you know how many coffees you prepared with the different coffee buttons. The beautiful housing, cup illumination and informative LED display make the S9 OT the most versatile Super Automatic Coffee Center available today. Enjoy your Impressa S9 One Touch!

3a. BEAN-TO-CUP / "CREMA COFFEE" / HIGH PRESSURE BREWING

According to the majority of coffee experts, grinding the beans just before brewing, tamping and brewing under high pressure is the ideal extracting process for maximum flavor and aroma. Your S9 OT automatic coffee center will always produce espresso and coffee with a thick, foamy layer called "crema." The crema traps the fine aromatics and the light gaseous flavors that register on the palate. The high pressure and the short brewing time prevent the extraction of bitter oils and release less caffeine than any other brewing method. You will always make the absolute freshest and most aromatic cup of coffee. This is the reason why many European restaurants and hotels serve only fresh pressurized brewed coffee. Experiment with your S9 OT and prepare the best and most enjoyable cup of coffee!

3b. DIFFERENT COFFEE DRINKS

Here are some guidelines for the most popular coffee drinks:

- Ristretto: 1/2 to 1 oz. of coffee. Sweeten to taste.
- Espresso: 1 to 2 oz. coffee. Sweeten to taste.
- Double Shot: 3 to 4 oz. of coffee. Sweeten to taste.
- Crema Coffee: 5 to 8 oz. of coffee.
- Cappuccino: 3 to 4 oz. of hot frothed milk plus espresso.
- Latte: 3 to 5 oz. steamed milk with little or no froth plus espresso.
- Latte Macchiato: 5 to 6 oz. of frothed/steamed milk produced with pause*, plus one or two shots of espresso. *The pause separates the milk froth and the milk and allows the espresso to settle "in between" (chapter 10d).
- Café Mocha: Use chocolate milk then proceed as in making cappuccino or latte.

Experiment with the size of your milk based drinks. For stronger coffee taste add more coffee, for more milk taste add more frothed/steamed milk.

3c. COFFEE FACTS

- **Caffeine** is tasteless. A "strong" coffee or espresso is mostly the result of the amount of coffee in relation to the amount of water. The longer a bean is roasted, the less caffeine it has. The shorter the brewing time the less caffeine in your cup.
- **Arabica and Robusta** are two genetically different kinds of beans. "Arabica" beans have more flavor and a little less caffeine than "Robusta" beans which are mostly used in lower priced coffees and instant coffees.
- **Espresso** is not a bean! It's the way the coffee is roasted and prepared. Typical US espresso roasts result in darker beans with an oily surface. European espresso roasts are medium brown with no or very little oils on the surface.

All Display Messages Are Shown in **RED**

4. PLEASE, DON'T... (or you void your warranty protection):

- Never pull out the drawer during the brewing process. Only pull the drawer when the display instructs you or when the display shows **COFFEE READY**.
- Never fill instant coffee into the bean container or ground coffee funnel; it will damage the brewing chamber.
- Never fill sugar coated coffee beans into the bean container.
- Never fill frozen beans into the bean container. Do not keep beans in the freezer. Store them in a dark, airtight container.
- Never fill anything other than coffee beans into the bean container (no chocolate, rice, nuts, spices, etc.).

- Never fill anything but fresh, cold clean water into the water container, except when decalcifying (chapter 17.1).
- Never use mineral or carbonated water. You can use tap water, bottled water, spring water, distilled water and reverse osmosis water.
- Never repair or open the machine yourself. All repairs should be performed only by an authorized service center.
- Do not place the machine on a surface which is sensitive to hot or cold water and steam. Never place the machine on an uneven surface.

PLEASE, DO...

- Fill water tank daily with fresh, cold water.
- Before filling the bean container, remove any foreign particles (small stones) from coffee beans.
- Let frozen beans thaw for 3 to 4 hours before pouring them into the bean container.

Important: If you pull out the drawer at any time you must empty the used coffee container and the drawer. If you do not empty the container, used coffee will overflow inside the machine and can cause serious damage to the internal mechanism.

5. FACTORY SETTINGS / OPTIONS

The IMPRESSA S9 One Touch can be set up in many different ways. Beverages, on/off settings, temperature, rinse cycles, water treatment, energy savings modes and display information can be programmed to your personal preferences.

Beverage buttons can be customized with regards to volume (cup size), coffee strength (**AROMA**), temperature, duration of milk steaming/frothing.

Coffee volume:

- All 1-cup buttons can be programmed to brew between 0.5 and 8 oz. of coffee.
- The Hot Water Portion can be programmed to dispense up to 15 oz. of hot water.
- All 2-cup buttons can be programmed to brew between 0.5 and 8 oz. per cup, total of 16 oz. max.

Tip: if you use a 12 oz. mug and program one of the 2-cup buttons to 5 oz. the S9 OT will brew a total of 10 oz. of coffee into your mug.

Coffee strength (**AROMA**):

- All 1-cup buttons can be set to five different coffee strengths: **XMILD, MILD, NORMAL, STRONG, XSTRONG**. In XMILD the conical burrs grind for approx. 5 seconds, in XSTRONG, the grinding takes about 9 seconds.
- When using the 2-cup buttons, the S9 OT will always grind in XSTRONG.

Please note: The display indicates the five strength settings with graphics showing from one to five coffee beans.

Temperature:

- All coffee buttons can be set to **NORMAL** or **HIGH**.
- The Hot Water function can be set to **LOW, NORMAL, XHIGH** (XHIGH is used for pre-warming cups and for specialty teas).

Steaming for milk frothing:

- The cappuccino and latte macchiato buttons and the milk portion can be set to produce steam from 3 to 120 seconds.

Latte Macchiato Pause:

- The pause between milk frothing and coffee brewing can be set from 0 to 60 seconds.

Factory Settings for Beverage Buttons:

- All coffee buttons are set to temperature **HIGH**.
- The hot water function is set to **XHIGH**.
- 1-CUP Espresso button (Fig. 2,C) 2 oz./ **STRONG**.
- 2-CUP Espresso button (Fig. 2,F) 2 oz. per cup / **XSTRONG**.
- 1-CUP Coffee button (Fig. 2,D) 5 oz./ **STRONG**.
- 2-CUP Coffee button (Fig. 2,G) 5 oz. per cup / **XSTRONG**.
- A La Carte button (Fig. 3A,N) 7 oz.
- Cappuccino; one-touch button (Fig. 3.6) 14 seconds milk, 0 seconds pause, 2 oz. coffee / **NORMAL**.
- Latte Macchiato; one-touch button (Fig. 3.7) 14 seconds milk, 15 seconds pause, 2 oz. coffee / **STRONG**.
- Milk portion; Selector Dial (Fig. 3.5) 14 seconds milk,
- Water Portion; Selector Dial, 5 oz.; **XHIGH**.

Other Factory Settings:

- 5-hour auto shut-off.
- Water hardness setting: **10°dH**.
- Filter: **FILTER NO** (Clearyl Water Care Cartridge: not installed)
- Language: English.
- Display: **AM/PM** and **OZ**.
- Economy Mode (energy saving): Off
- Time / Weekday: **--:--** (not set)
- Automatic On and Off times: not set
- Cappuccino Rinsing: set to **NOW**; display shows **CAPPUCCINO RINSING** immediately after frothing milk.

6. PREPARING THE MACHINE FOR THE FIRST TIME

- Make sure all accessories, literature and any other items are removed from the bean container and the water tank.

- DO NOT install the Clearyl water filter now (chapter 13a).
- Make sure the machine sits on an even, flat surface and the drawer and used coffee container are inserted (Fig. 1).
- Plug-in machine.

6a. FILLING THE WATER TANK

Please note: Only use fresh, cold water. Never fill water tank with carbonated water, milk or any other liquid.

- Remove the water tank, rinse and fill with fresh, cold water.
- Replace water tank and make sure that it engages securely.

6b. FILLING THE BEAN CONTAINER

Please note: To insure that the conical burr grinder will work for a long time, do not use it with any kind of coated or flavored beans (all coating and flavors contain sugar or sugar substances). Such coating can damage the burrs. Using such beans voids the warranty. Have your coffee store grind the sugar coated beans and use as described in chapter 9e.

Flavored Coffee: If you like flavored coffees we recommend adding flavors to your coffee after brewing. This way you can use your regular coffee beans in the bean container. Adding the flavors after brewing lets you control the flavor intensity much better than with pre-flavored coffee. Your local coffee store typically carries a variety of liquid flavors.

- Open the Cover Lid (Fig. 5).
- Remove the Aroma Protection Lid (Fig. 6).
- Make sure the bean container is empty and clean. Fill beans into the bean container (Fig. 7).

Frozen Beans: Thaw 3 to 4 hours before adding to bean container. This prevents moisture from seeping into the grinder.

Oily Beans: Beans with an oily surface tend to stick together. This may prevent a continuous flow of beans from the bean container into the burrs. As a result the grinder does not grind enough coffee and you might get weak or no coffee at all. Stir the beans in the bean container just before grinding. Alternatively, you can also pour the beans into an open bowl and let them sit for about 5 hours. The oils will evaporate (this will not change the taste of your coffee). Then fill the beans into the bean grinder. Now beans will feed into the burrs more easily.

6c. TURNING THE MACHINE ON FOR THE FIRST TIME

- Make sure bean container and water tank are filled.
- Press the Main Power Switch in the back of the machine (Fig. 1b) The On/Off button illuminates (Fig. 2.B).
- Push the On/Off button. The display shows **FILL SYSTEM / PRESS RINSE** and the Rinse button (Fig. 2.E) illuminates.
- Place containers underneath the Auto Cappuccino System and the Hot Water Spout (Fig. 4) and push the Rinse button (Fig. 2.E). **SYSTEM FILLING.** The machine will dispense a small amount of water. **HEATING UP / PRESS RINSE.**
- Place cup underneath the dual coffee spout (Fig. 4) and press the Rinse button (Fig. 2.E). **MACHINE RINSING.** The machine will dispense a small amount of water. **COFFEE READY.**

Please note: You can only make coffee when the display reads **COFFEE READY.**

- Place a cup under the coffee spout and push one of the coffee buttons. The machine will grind and brew coffee. If the display shows **FILL BEANS** push one of the coffee buttons again.
- Discard the first two cups of coffee.
You are now ready to brew coffee.

6d. CUP ILLUMINATION

The cup illumination adds a dramatic touch to brewing coffee. Providing the machine is plugged in, you can activate the cup illumination for 3 minutes by pressing any button.

7. ADJUSTING THE GRINDER

IMPORTANT: The grinding grade can only be adjusted while the grinder is actually grinding.

Adjust the grinder to the roast of your coffee.

- Light roast: use a finer adjustment (smaller dots).
- Dark roast: use a coarser adjustment (larger dots).
- Open the cover of the bean container (Fig. 5).
- To adjust fineness, turn the grinding wheel during grinding to the desired position (Fig. 9).

ATTENTION: Oily beans tend to stick together. Stir beans just before grinding to ensure a proper flow of beans into the burrs.

Please note: If coffee does not flow through the Dual Coffee Spouts in a constant stream, turn the wheel to a coarser setting.

8. DAILY PREPARATION

Fill the water container every morning with fresh, cold water. This will enhance the taste of your coffee.

- Make sure the Main Power Switch is on (Fig. 1b). In this case the On/Off button is illuminated.
- Push the On/Off button. The display shows **WELCOME TO JURA** and then **HEATING UP.** After approx. 2 minutes the display shows **PRESS RINSE.**
- Push the Rinse Button* (Fig. 2,E). Hot water will warm up all internal parts and pump through the coffee spouts **MACHINE**

RINSING. The water will be caught in the drawer underneath. The rinse cycle stops by itself and the display reads: **COFFEE READY.** You are now ready to make coffee.

***Note:** S9 OT can be programmed to automatically start the rinsing cycle after **HEATING UP** is displayed (chapter 14.7).

8a. TURNING THE MACHINE OFF / RINSING

Before turning off the S9 OT, place containers under the Dual Coffee Spouts and Auto Cappuccino System (Fig. 4).

When the S9 OT is turned off or turns itself off it will prompt for short cleaning cycles as follows:

Only the Dual Coffee spouts were used: The S9 OT displays **MACHINE RINSING.** For a few seconds hot water will be dispensed through the Dual Coffee Spouts and through the coffee spout of the Cappuccino section. The machine and the display turn off.

The Auto Cappuccino Spouts and the Dual Coffee Spouts were used: The S9 OT first displays **CLEAN CAPPUCCINO** and the Rinse button illuminates. If the Rinse button is not pushed within the next ten seconds, the display shows **SPOUT RIGHT / PRESS RINSE.** Press the Rinse button. The S9 OT will dispense some hot water through the coffee spout of the Cappuccino section. It will then push some hot water through the Dual Coffee Spouts and turn off.

Please note: When the S9 OT turns off you may hear a slight hissing noise.

9. COFFEE PREPARATION

9a. PRE-WARM CUPS

In the morning pre-warm your cups with hot water through the Hot Water Spout. Cold cups reduce the coffee temperature by 5°F to 10°F.

Place a cup under the Hot Water Spout, turn the Selector Dial (Fig. 3.3) until the display shows **HOT WATER** and push the Selector Dial. The display shows **TEMP. XHIGH** and water will flow into your cup. Push the Selector Dial again to stop and discard the water. **COFFEE READY.**

9b. BREWING COFFEE AND ESPRESSO

The machine has four pre-set coffee buttons, **1 ESPRESSO, 2 ESPRESSI, 1 COFFEE, 2 COFFEES** (Fig. 2).

All buttons are pre-set for coffee strength, coffee volume and temperature (chapter 5).

- Place one or two cups underneath the Dual Coffee Spouts and push the desired button. The machine will grind, tamp and then brew the coffee. It uses a 2-step brewing process (pre-brew phase), pauses for a few seconds, and then starts the brewing process. The display will show the name of the button you pushed, e.g. **1 ESPRESSO** and the selected coffee strength indicated by a bean graphic, e.g. 4 beans = strong.

Please note: when pushing any of the two-cup buttons, the coffee strength is not displayed.

Important: After the brewing stops the machine will discard the used coffee grounds. Please do not try to pull out the drawer (Fig.1,18) during this operation. It can seriously damage the machine. There is no need to pull out the drawer until the display shows the message **EMPTY TRAY** or **EMPTY GROUNDS.**

Please note: You can always stop the brewing process by pressing any of the coffee buttons.

9c. OVERRIDING STRENGTH AND CUP SIZE DURING BREWING

During brewing you can override the strength of the two one-cup buttons (Fig. 2, C, D) and the cup size of all four coffee buttons. When using the two-cup buttons the S9 OT automatically selects the maximum strength. Overriding will not change the factory setting (chapter 5).

Example:

- Open the cover for the Rotary Dial (Fig. 1.19).
- Push the 1-Cup Coffee Button (Fig. 2D).
- During grinding turn the Rotary Dial to change the strength to e.g. XSTRONG (5 bean graphic). The display shows the selected strength.
- When the coffee starts brewing, turn Rotary Dial until the display shows, e.g. **7.0 OZ**. The S9 OT will brew 7.0 oz of coffee.

If you use the same coffee button again and do not use the Rotary Dial, the S9 OT will brew a cup according to the programmed settings for this button.

Please note: When using one of the 2-Cup buttons you can only change the cup size. The display shows the amount per cup, e.g. **6.0 OZ**; the S9 OT will brew a total of 12 ounces. For re-programming see chapter 11 (cup sizes) and chapter 14.1 for cup sizes, temperature and strength.

9d. THE A LA CARTE BUTTON

The S9OT has a fifth coffee button (Fig. 3A,N). With this button you can change the coffee volume and the coffee strength just

before brewing. **COFFEE READY**.

- Push the A LA CARTE button (Fig. 3A,N). The display shows **A LA CARTE** and the strengths indicated by the bean graphic e.g. 2 beans (mild).
- Turn the Rotary Dial to choose any of five strength settings: **XMILD**, **MILD**, **NORMAL**, **STRONG**, **XSTRONG**, indicated by 1 to 5 beans in the bean graphic.
- Then push the Rotary Dial. The machine starts grinding. Now dial the coffee volume.

Please note: If you push the A LA CARTE button and do not push the Rotary Dial within a few seconds, the display will revert to **COFFEE READY**.

9e. USING PRE-GROUND COFFEE

You can also use pre-ground coffee, bypassing the grinder. This is convenient if someone requests decaf coffee or a decaf cappuccino or flavored coffee.

Please note: Never fill the funnel with instant coffee. Do not fill the funnel with more than two scoops. The funnel is not a storage container. If coffee is ground too fine the brewing process may be stopped.

COFFEE READY

- Open cover (Fig. 1,19) and push the Ground Coffee button (Fig. 3A,O). **FILL PRE-GROUND / COFFEE READY**.
- Fill 1 or 2 level measuring scoops of ground coffee into the opening for ground coffee (Fig. 1,11) and close the lid.
- Now push one of the four coffee buttons to brew your coffee e.g. **1 COFFEE**. The pre-ground coffee is tamped and brewed. **ENJOY**, then **COFFEE READY**.

Please note: If the Ground Coffee button (Fig. 3A,O) is pressed by mistake just press one of the coffee buttons, **NOT ENOUGH PRE-GROUND**. The machine will automatically stop and return to **COFFEE READY**.

Please note: After use of sugar coated or flavored coffee through the pre-ground coffee funnel you may experience some flavor transfer when switching back to your regular coffee.

10. AUTO CAPPUCCINO SYSTEM

The S9 OT features the Auto Cappuccino System with two spouts located behind each other (Fig. 15) The front spout produces steam (steam nozzle). The rear spout produces high pressure brewed coffee. Attached to the steam nozzle is the removable frothXpress system. It siphons, steams and froths milk.

The S9 OT Cappuccino System prepares a variety of milk based drinks without ever moving the cup: Cappuccino, Latte, Latte Macchiato, Café Mocha, Hot Milk, Hot Chocolate.

10a. PREPARING THE THERMAL MILK CONTAINER

The S9 OT comes with a 20 oz. double walled vacuum stainless steel container. This custom-made milk container can keep cold milk cold for up to eight hours. There is no need to worry about the milk getting warm during the day.

The milk container comes complete with: • lid and attached stainless steel hose • two short flexible hoses • one long flexible hose • spare black and transparent fittings (Fig. 14a, 14b).

The two short hoses have a connecting piece on each end.

- Unscrew the milk container lid. A stainless steel hose is attached to the inside of the container. A small transparent fitting holds the hose in place (a spare fitting is included).

- Rinse the milk container with fresh water before first use and fill with fresh cold milk. Close the lid.
- Insert one end of the short flexible hose into the lid opening.
- Remove the red cap from the side of the frothXpress and insert the other end of the short flexible hose (Fig. 15).

You are ready to steam/froth milk.

Storing the milk container: always remove the outside flexible hose and open the lid before storing the milk container in the refrigerator.

Important: The milk container is not dish washer safe. Do not immerse the milk container in any liquid.

Using the long flexible hose: To siphon milk directly from a milk carton use the long flexible hose. Insert one of the black connecting pieces in the straight-cut end of the hose and insert into the frothXpress. Insert the other end with the V-cut into the milk container (Fig. 17).

10b. THE FROTHXPRESS SYSTEM

This system produces unlimited amounts of hot steamed or frothed milk right into your cup.

Important: This system siphons milk and mixes it inside the frothXpress with hot steam. It is necessary that all parts are connected tightly, otherwise the siphoning process will not work.

Frothing Position: The dial points to the upper part of the face (12 to 2 o'clock). This section is used for Cappuccino and Latte Macchiato. In the 12 o'clock position the frothXpress creates the most milk froth. Turning the dial towards the 2 o'clock position increases the milk temperature (Fig. 16).

Steaming Position: The dial points to the lower part of the face

(6 to 4 o'clock). Milk will be steamed, not frothed. Turning the dial towards the 4 o'clock position increases milk temperature.

Steam Only Position: When the dial points to the steam symbol (3 o'clock), the siphoning is blocked. Only steam will pass through the frotherXpress.

10c. PREPARING ONE-TOUCH CAPPUCCINO, CAFÉ MOCHA AND LATTE

COFFEE READY.

The frothXpress dial points to area between 12 and 2 o'clock
The milk container is connected.

- Place your cappuccino cup underneath the Cappuccino system and push the cappuccino button (Fig. 3.6). The S9 OT starts grinding, the display shows **CAPPUCCINO** and the coffee strength (bean graphic). It then siphons, heats and froths milk for 14 seconds and adds 2 oz. of high-pressure brewed coffee (Factory Settings, chapter 5). The display shows **ENJOY** then **COFFEE READY**.

Tip: If you use a glass cup you can see how much froth is created and how the coffee sits beneath the layer of milk froth. Slightly stir to distribute the coffee evenly into the hot milk.

CAFÉ MOCHA: use chocolate milk or add chocolate syrup to your cold milk and stir then proceed as explained before.

LATTE: turn the frothXpress dial between the 4 and 6 o'clock position and repeat above steps. Milk is steamed without froth.

Please note: You can always add an additional shot of espresso by placing your cup under the Dual Coffee Spouts (Fig. 4) and pushing the 1-Cup Espresso button. You can also add additional hot milk (chapter 10e).

Please note: You can always stop the beverage preparation by pushing any of the beverage buttons.

10d. PREPARING ONE-TOUCH LATTE MACCHIATO

This beverage is very popular in Europe. It is normally served in glasses, approx. 4 to 5 inches tall and 2 inches in diameter.

COFFEE READY.

The frothXpress dial points to the 12 to 2 o'clock position.

- Place your latte macchiato glass underneath the Cappuccino system and push the Latte Macchiato button (Fig. 3.7). The S9 OT starts grinding, the display shows **LATTE MAC**, and the coffee strength. It then siphons, heats and froths milk for 14 seconds and pauses. The display shows **PAUSE** (factory setting is 15 seconds). During this time the milk separates from the milk froth. After the pause 2 oz. of high-pressure brewed coffee are automatically added. **LATTE MAC**. Then **ENJOY**. The coffee settles between the froth and the milk giving the beverage the typical multi-layered, Latte Macchiato look. **COFFEE READY**.

10e. PREPARING HOT MILK / HOT CHOCOLATE

The Cappuccino System can produce hot milk or hot chocolate without brewing coffee.

COFFEE READY.

- Connect the milk container to the frothXpress system or use the long flexible hose inserted into any milk carton.
- Place your cup underneath the Cappuccino system.
- Turn the Selector Dial (Fig. 3.3) until the display shows **MILK** or **MILK PORTION** ("MILK" siphons milk until you stop the action by pushing the Selector Dial button again.

"MILK PORTION" siphons milk for a programmed time and stops automatically).

- Push the button inside the Selector Dial. The display shows **MILK** or **MILK PORTION**. During this time hot steamed / frothed milk is created and delivered into your cup.
COFFEE READY.

10f. OVERRIDING THE CAPPUCCINO SETTINGS

As with the coffee buttons you can override the pre-programmed volumes of the milk beverage buttons.

Example: The factory setting for the Cappuccino button is normal strength (3 beans graphic), 14 seconds of milk frothing and 2 oz. of coffee. Prepare a one-time special cappuccino, extra strong (5 beans graphic), more milk froth (20 seconds) and 3 oz. of coffee.
COFFEE READY

- Place your cappuccino cup under the Cappuccino system and open the cover for the Rotary Dial (Fig. 1.19).
- Push the Cappuccino Button (Fig. 3.6). During grinding turn the Rotary Dial to change the strength until the display shows the 5 bean-graphic.
- When the frothing starts turn the rotary dial until the display shows **20 SEC.**
- When the coffee brewing starts turn the Rotary Dial until the display shows **3.0 OZ.**

10g. CAPPUCCINO RINSING

In only a few seconds this rinsing program removes milk droplets inside the frothXpress.

After preparing a beverage with milk (Cappuccino Button, Latte Macchiato Button, Milk, Milk Portion) the S9 OT display shows

COFFEE READY / RINSE CAPPUCCINO and the Rinse button illuminates. You can still continue making any beverages. We recommend to perform the cappuccino rinsing since it takes only a few seconds and makes sure that your frothXpress is free of any milk.

- Turn the frothXpress dial to the 3 o'clock position (Fig. 16) and place a cup underneath the cappuccino system.
- Push the Rinse button. The display shows **CAPPU. RINSING.** Hot water is pushed through the frothXpress for a few seconds.
COFFEE READY.
- Turn the frothXpress dial back to your preferred position.

IMPORTANT: If you do not use the Cappuccino Rinsing cycle, milk droplets might harden inside the frothXpress, resulting in insufficient frothing performance.

10h. USING HOT WATER

The hot water function lets you pre-warm cups, brew tea, make a quick cup of soup, or add hot water to your coffee or espresso to create a milder flavor.

- Place a cup under the hot water spout (Fig. 4).
- Turn the Selector Dial (Fig. 3.3) until the display shows **HOT WATER** or **HOT WATER PORTION** (HOT WATER PORTION delivers a pre-programmed amount of hot water and then stops automatically. HOT WATER delivers hot water until you stop the action by pushing the Selector Dial button again).
- Push the button inside the Selector Dial. The display shows the pre-set temperature e.g. **TEMPERAT. X HIGH** and then **HOT WATER** or **HOT WATER PORTION.**
COFFEE READY.

The temperature for this function can be set to LOW, NORMAL and XHIGH (chapter 14.1; example 3)

You can override the WATER PORTION during the hot water release with the Rotary Dial.

You can re-program the hot water portion (chapter 14.1).

11. VISUAL PROGRAMMING OF BEVERAGE PORTIONS

Chapters 14 and 14.1 explain how to re-program all parameters (volume, strength, temperature) for the beverage buttons.

Re-programming the cup size for coffee and milk can also be done during beverage preparation as follows:

- Push and hold the beverage button you want to re-program until display shows **ENOUGH COFFEE?** or **ENOUGH MILK?** This way you can make sure your (cappuccino) cup is completely filled with milk and coffee.

Example:

Visually re-programming the Cappuccino button (Fig 3.6).

COFFEE READY.

- Prepare the Cappuccino Systems (milk container etc) to make a cappuccino and place your cappuccino cup under the frothXpress.
- Push and hold the Cappuccino button until display shows **ENOUGH MILK?**
- When the desired amount of milk and milk froth is in your cup, push the Cappuccino button again. The display now shows **ENOUGH COFFEE?**
- When enough coffee has been added to your frothed milk push the Cappuccino button again. **CONFIRMED ✓**, then **ENJOY**, then **COFFEE READY.**

The next time you push the Cappuccino button, the S9 OT will produce that amount of milk and coffee.

12. WATER CARE

The S9 OT works with: • tap water • bottled water • distilled water. We recommend using tap water or bottled water. Distilled water has no minerals and does not improve the taste of coffee. Water that is heated inside the machine leads to calcium deposits. Tap water has a varying degree of water hardness (chapter 12a). Most bottled water has a low level of water hardness.

IMPORTANT: do not use carbonated water or any other liquid in the water tank.

You have the following options to take care of the water.

- Decalcifying System (chapter 17.1).
- Clearyl Water Filter Cartridge (chapter 13a).

The machine is factory pre-set to automatically remind you to decalcify.

12a. WATER HARDNESS MONITOR

Your S9 OT is set to a water hardness of **10°dH** and will automatically indicate when it is time to perform a decalcifying cycle. You can change the water hardness setting from 1° to 30°dH. If you are not sure about the hardness of your water, ask your local water company for the "Water Hardness in Grains." The machine displays the water hardness in the German hardness scale which is a bit different from the American "Grain" scale (see chart below). You can also use the water hardness indicator strip ("Aquadur" in Welcome Pack) to determine the water hardness:

- Insert the strip for one second into the water you want to use. Shake off any excess water and wait for one minute.

- One or more sections of the indicator strip will turn reddish.
- Change the water hardness setting according to the table below.

Level	Display	Display German Degree	Equivalent American Grains	Indicator Strip number of "reddish" fields
Not Active*	INACTIVE	—	—	—
1. extremely soft water	□□□□□	1-4	1-5	None
2. soft water	■□□□□	5-9	6-11	1 to 2
3. medium water	■□□□□	10-14	13-18	2 to 3
4. hard water	■□□□□	15-19	19-24	3 to 4
5. very hard water	■□□□□	20-24	25-30	4 to 5
6. extremely hard water	■□□□□	25-30	32-38	All 5

*Not Active: You can only use this setting for distilled water.

Level 5 and Level 6: If the tap water falls into these two categories, decalcifying will be frequent. In this case bottled water is recommended. Most bottled water has a low calcium level.

Please note: If your water has a high calcium content (level 5 or 6) and you use the Clearyl Filter Cartridge we recommend to decalcify the machine once or twice a year (chapter 17 and 17.1).

Please note: If you use Spring or Bottled Water with low calcium levels you can set the hardness to 3°dH, "extremely soft water".

12b. CHANGING THE WATER HARDNESS MONITOR

COFFEE READY

Example: change the hardness setting from 10°dH to 20°dH

- Push the Rotary Dial until display shows **MAINTENANCE**.
- Turn Rotary Dial until the display shows **HARDNESS 10° DH**.

- Push the Rotary Dial to enter the program.
- Turn the Rotary Dial until the display shows **20°dH**.
- Push the Rotary Dial to confirm the setting. **CONFIRMED ✓** and then **HARDNESS 20°dH**.
- Turn the Rotary Dial until the display shows **EXIT**.
- Push the Rotary Dial **COFFEE READY**.

The machine will automatically remind you when it is time to decalcify (chapter 17.1).

Please note: You can set the hardness monitor to **INACTIVE**. In this case you must use distilled water. In this setting the S9 OT will not remind you to decalcify the machine.

13. CLEARYL WATER FILTER CARTRIDGE

The machine comes with one Clearyl Water Filter Cartridge. The Clearyl cartridge

- Reduces the water hardness up to 75%.
- Removes (if present) up to 85% chlorine, up to 90% lead, up to 95% copper and up to 67% aluminum.
- Cleans the water through an upward current principle (Fig. 10) just before the brewing cycle starts, ensuring freshly filtered water every time you make coffee.
- Lasts for 75 liters (~2,500 oz.) of water or up to two months.
- Eliminates decalcifying except when using very hard water (25 grains or higher), see chapter 12. In this case we recommended to decalcify the machine once or twice a year.
- To reorder cartridges, see chapter 20.

13a. INSTALLING & ACTIVATING THE CLEARLY WATER CARTRIDGE

Installing:

- Important:** Never install the cartridge before or during "Preparing Machine For The First Time" (chapter 6).
- Remove cartridge from its bag and rinse cartridge under water.
 - Add the extension rod to the cartridge (Fig. 11).
 - Remove the water tank, make sure it is empty.
 - Pull up the cartridge holder and insert the cartridge with its tapered end down into the water container (Fig. 12, Fig. 13). Make sure it fits securely inside the fins. Push down gently (Fig. 13).
 - Close the cartridge holder. Make sure the holder snaps into place.
 - Fill the water tank with fresh cold water and replace.

Activating:

You must activate the cartridge for the machine to monitor it properly. Otherwise the S9 OT assumes decalcifying mode.

COFFEE READY.

1. Push the Rotary Dial until display shows **MAINTENANCE.**
2. Turn the Rotary Dial until the display shows **FILTER NO** and push the Rotary Dial to enter the program.
3. Turn the Rotary Dial until **FILTER YES** is displayed and push the Rotary Dial. **CONFIRMED ✓** is displayed briefly and then **INSERT FILTER/PRESS STEAM.** The Rinse button illuminates.
4. Place a 20 oz. container under the frothXpress (Fig. 4) and turn the frothXpress dial to the 3 o'clock position.
5. Push the Rinse Button. **FILTER RINSING.** For the next 60 seconds the machine will push water through the cartridge

and out through the frothXpress system. Initially, the water may have a slight discoloration. The program will stop automatically.

The display shows **COFFEE READY.**

6. Turn the frothXpress dial back to your preferred setting.
Please note: As long as the filter is activated, the water hardness setting is automatically turned off.

13b. AUTOMATIC CLEARLY REPLACEMENT

The filter is monitored automatically. After approx. 75 liters of water (~2,500 oz.) the display shows **COFFEE READY / CHANGE FILTER.** The Rinse Button will light up.

Important: Once the filter has lost its calcium suppressing abilities, calcium will build up inside the machine. Since the Water Hardness Selector is off, the machine will not remind you when to decalcify. If the filter is not replaced, the calcium build-up will clog and damage your machine.

- Push the Rinse Button. **DURATION 2 MIN. / START YES.**

Please note: To change and activate the filter at a later time, turn the Rotary Dial until the display shows **START NO.** Push the Rotary Dial to exit the program. In this case the S9 OT will still remind you with the message **CHANGE FILTER.**

1. Push Rinse Button again. **CHANGE FILTER /PRESS RINSE.**
2. Remove the water tank and the old filter and set the extension rod aside. **Important:** Keep the extension rod.
3. Make sure the water tank is empty.
4. Remove the new cartridge from its bag and rinse under running water. Now install as explained in chapter 13a, steps 4 through 6.

13c. MANUAL CLEARYL REPLACEMENT

If the filter is more than 2 months old and the display does not indicate to replace filter, replace as follows.

COFFEE READY.

- Push the Rotary Dial until the display shows **MAINTENANCE**.
- Push Rotary Dial again, display shows **CLEAN CAPPUCCINO**.
- Turn the Rotary Dial until the display shows **CHANGE FILTER**.
- Push the Rotary Dial. The display shows **DURATION 2 MIN./START YES**.
- Push Rotary Dial again. Display shows **INSERT FILTER / PRESS STEAM**.
- Now install as explained in chapter 13a, steps 4 through 6.

13d. DO NOT LET THE CLEARYL FILTER DRY OUT!

If the filter is not immersed in water for a few days the granular inside will dry out and block any water from passing through.

- If machine is not used for a few days, leave some water in the water tank so the filter will not dry out. Upon using the machine again, fill the water tank with fresh water and process approx. 2 oz. of water through the hot water spout. You now have fresh water for your first cup of coffee.
- If the machine is not used for a longer period of time, empty the water container and remove the CLEARYL filter. Fill a glass with at least 2 inches of water and immerse the filter. Place the glass in the refrigerator.
- When you use the machine again, install the filter.

14. PROGRAMMING

The S9 OT provides programming, maintenance and look-up functions. With the display at **COFFEE READY** you can access the following functions:

- Push the Rotary Dial until display shows **MAINTENANCE**. Turning the Rotary Dial clockwise the display shows the following functions:

	Chapter
MAINTENANCE	15.1
PRODUCTS	14.1 (beverage buttons)
FILTER NO or YES	13a
HARDNESS 10°Dh	12b If FILTER YES this function is suppressed.
ECONOMY MODE -	14.3
TIME --,--	14.4
UNIT ON/OFF	14.5
OFF AFTER	14.6
RINSES	14.7
INFORMATION	14.8
SETTING AM/PM / OZ ..	14.9
LANGUAGE ENGLISH	14.10
EXIT	

Please note: to get back to **COFFEE READY**, turn the Rotary Dial until the display shows **EXIT**, then push the Rotary Dial.

14.1 RE-PROGRAMMING BEVERAGE BUTTONS (PRODUCTS)

This program allows you to change all parameters for all beverage functions.

The following parameters can be changed, where applicable:

Coffee volume (WATER): for all 1-cup buttons from 0.5 to 8 oz., for all 2-cup buttons from 0.5 to 8 oz. per cup (max total 16 oz.)

Coffee strength (AROMA) for all 1 cup buttons choose from five settings: **XMILD**, **MILD**, **NORMAL**, **STRONG**, **XSTRONG**. The display shows from one to five coffee beans to indicate the selected strength during brewing.

Temperature: for all coffee drinks the temperature can be set to **NORMAL** or **HIGH**

MILK PORTION: steaming can be set from 3 to 120 seconds.

PAUSE: the pause time between milk production and coffee brewing for the one-touch Cappuccino and Latte Macchiato buttons can be set from 0 to 60 seconds.

HOT WATER PORTION: can be set from 0.5 to 15 oz.

The temperature for the hot water function can be set to **LOW**, **NORMAL** or **XHIGH** (for specialty teas and pre-warming cups).

Example 1:

Re-program the 1-Cup Coffee button to:

4 ounces of coffee, mild, normal temperature.

COFFEE READY

1. Push the Rotary Dial until the display shows **MAINTENANCE**.
2. Turn the Rotary Dial to **PRODUCTS** and push the Rotary Dial. The display shows **SELECT PRODUCT**.
3. Push the 1-CUP COFFEE button. The display shows the current volume setting, e.g. **WATER 5.0 OZ.**
4. Push the Rotary Dial: **WATER 5.0 OZ** and turn the dial until the display shows **WATER 4.0 OZ.**
5. Push the Dial to confirm: **CONFIRMED ✓** then **WATER 4.0 OZ.**
6. Turn the Rotary Dial until the display shows **AROMA** and the current strength setting, e.g. three beans graphic.
7. Push the Rotary Dial, **NORMAL** with three beans graphic, and turn the Dial until display shows **MILD** with two beans.
8. Push the Rotary Dial to confirm: **CONFIRMED ✓** then **MILD** with two beans.
9. Turn the Dial until the display shows **TEMPERAT. HIGH** and push the Rotary Dial **TEMPERAT. HIGH**.

10. Turn the Dial until the display shows **TEMPERAT. NORMAL**.

11. Push the Rotary Dial to confirm: **CONFIRMED ✓** then **TEMPERAT. NORMAL**.

12. Turn the Rotary Dial until the display shows **EXIT** and push the Rotary Dial. **SELECT PRODUCT**.

13. If you do not want to change another button, turn the dial until the display shows **EXIT** and push the Rotary Dial: **COFFEE READY**.

Example 2:

Re-program the Latte Macchiato button to:

3.5 oz. of coffee, extra strong, milk production for 20 seconds, pause to 10 seconds, temperature stays as is (HIGH).

COFFEE READY

1. Push the Rotary Dial until the display shows **MAINTENANCE**.
2. Turn the Rotary Dial to **PRODUCTS** and push the Rotary Dial. The display shows **SELECT PRODUCT**.
3. Push the Latte Macchiato button. The display shows the current coffee volume setting, e.g. **COFFEE 2.0 OZ.**
4. Push the Rotary Dial, **COFFEE 2.0 OZ**, and turn the dial until the display shows **COFFEE 3.5 OZ.**
5. Push the Rotary Dial to confirm: **CONFIRMED ✓** then **COFFEE 3.5 OZ.**
6. Turn the Rotary Dial until the display shows **AROMA** and the current strength setting, e.g. three beans.
7. Push the Rotary Dial, **STRONG** with four beans, and turn the Dial until the display shows **XSTRONG** with five beans.
8. Push the Rotary Dial to confirm: **CONFIRMED ✓** then **XSTRONG** with five beans.

9. Turn the Rotary Dial until the display shows **MILK 14 SEC**
10. Push the dial, **MILK 14 SEC**, and turn the dial until the display shows **MILK 20 SEC**.
11. Push the Rotary Dial to confirm: **CONFIRMED ✓** then **MILK 20 SEC**.
12. Push the Rotary Dial until the display shows **PAUSE 15 SEC**.
13. Push the Rotary Dial, **PAUSE 15 SEC**, and turn the Rotary Dial until the display shows **PAUSE 10 SEC**.
14. Push the Rotary Dial to confirm: **CONFIRMED ✓** then **PAUSE 10 SEC**.
15. Turn the Rotary Dial until the display shows **EXIT** and push the dial. **SELECT PRODUCT**.
16. If you do not want to change another button, turn the dial until the display shows **EXIT** and push the Rotary Dial: **COFFEE READY**.

Example 3:

Change the Hot Water Portion to 7 ounces and leave the temperature at XHIGH.

COFFEE READY

1. Push the Rotary Dial until the display shows **MAINTENANCE**.
2. Turn the Rotary Dial to **PRODUCTS** and push the Rotary Dial. The display shows **SELECT PRODUCT**.
3. Turn the Selector Dial (Fig. 3.3) on the right side until the symbol for the Hot Water Portion is illuminated (Fig. 3.1). Then push the Selector Dial.
4. Display shows the current water portion, e.g. **WATER 5 OZ**.
5. Push the Rotary Dial, **WATER 5 OZ**, and turn the dial until the display shows **WATER 7 OZ**.

6. Push the Rotary Dial to confirm: **CONFIRMED ✓** then **WATER 7 OZ**.
7. Turn the Rotary Dial until the display shows **EXIT** and push the dial. **SELECT PRODUCT**.
8. If you do not want to change another button, turn the dial until the display shows **EXIT** and push the Rotary Dial: **COFFEE READY**.

14.2 RESTORING FACTORY SETTINGS FOR BEVERAGE BUTTONS

You can reset the beverage buttons back to the factory setting as follows:

The machine is plugged in. Only the main power switch in the back of the machine is on. The display is blank.

Example: reset the 1-CUP Espresso button.

- Open the cover of the Rotary Dial.
- Push and hold the Rotary Dial and push the 1-Cup Espresso button for two seconds. The display shows **1 ESPRESSO OK**. The factory setting has been restored.

14.3 ECONOMY MODES

You can set the machine to three different modes.

ECONOMY MODE – (SAVE NO)

The S9 OT is always ready to brew coffee and produce steam.

The two white indicator lights in the cappuccino and latte macchiato button are always on.

ECONOMY MODE 1 (SAVE LEVEL 1)

The machine is always ready to brew coffee and is in the energy saving mode for steam.

If the machine is primarily used for coffee this setting saves energy. The heating element for steam (milk frothing) will shut off after approx. 10 minutes after last use. At this time the white indicator lights in the cappuccino and latte macchiato buttons turn off. To use the steam function, push the cappuccino or latte macchiato button. The lights will start blinking, indicating that the thermoblock for steam is heating up. This will take between 5 and 30 seconds depending how much that thermoblock was cooled down. Once the white indicator lights in those buttons are illuminated, you can push them again to make cappuccino.

ECONOMY MODE 2 (SAVE LEVEL 2)

This setting will save more energy than economy mode 1. Choose this setting if you prepare only a few coffees or cappuccinos in large intervals. It is much faster than turning the machine on and off every time you want to make coffee.

Five minutes after last use the S9 OT will lower the temperature and enter standby mode. When making coffee at a later time, the S9 OT will first heat up for 5 and 30 seconds.

Example:

Change from **ECONOMY MODE –** to **ECONOMY MODE 1**

COFFEE READY

- Push and hold the Rotary Dial. **MAINTENANCE**
- Turn the Dial until the display shows **ECONOMY MODE -**.
- Push the Dial, **SAVE NO** and turn to **SAVE LEVEL 1** and push the dial to confirm, **CONFIRMED ✓** then **ECONOMY MODE 1**.
- Turn the Dial to **EXIT** and push to return to **COFFEE READY**.

14.4 ACTUAL TIME and WEEKDAY

Setting the time allows you to program auto-on time.

Example:

Set the time to 7:15 AM and the weekday to Wednesday.

COFFEE READY

- Push the Rotary Dial until the display shows **MAINTENANCE**.
- Turn the Dial until the display shows **TIME -- / WEEKDAY**.
- Push the Dial and turn to **TIME** and push the dial again.
- Turn the Dial to select the hours **7:00 AM** and push to confirm.
- Now turn the Dial to set the minutes: **7:15 AM**.
- Push the Dial to confirm. **TIME 7:15 AM. CONFIRMED ✓**, then **TIME 7:15 AM**.
- Turn the Dial to **WEEKDAY** and push the dial.
- Turn the dial until display shows **WEDNESDAY** and push to confirm: **CONFIRMED ✓** then **WEEKDAY WEDNESDAY**.
- Turn Dial to **EXIT** and push to get back to **COFFEE READY**.

Please note: For Daylight Saving you have to re-set the time.

Please note: When fully charged, the built-in back-up battery keeps the clock running for up to eight weeks in case the S9 OT is unplugged or the main power switch in the back is turned off.

14.5 AUTO-ON and AUTO-OFF TIMES

You can set a time at which the machine automatically turns on and is ready to make coffee.

Please note: Auto-on/off times will only work if the actual time is set and the main power switch is turned on (the small red light in the On/Off switch is illuminated)

Please note: The Auto-on/off time function will apply to all days. You can select certain days of the week for the S9 OT not to turn on automatically. See the following example.

Example:

Set the On-time to **6:15 AM** and program the S9OT not to turn on automatically on Sundays.

COFFEE READY

- Push the Rotary Dial until the display shows **MAINTENANCE**.
- Turn the Dial until the display shows **UNIT ON/OFF**.
- Push the Dial **UNIT ON --.--**, push again **UNIT ON --.--**.
- Turn the dial to set the hours **UNIT ON 6:00 AM** and push the Dial to confirm. **UNIT ON 6:00 AM**.
- Turn the Dial to set the minutes **UNIT ON 6:15 AM** and push to confirm. **CONFIRMED ✓**, then **UNIT ON 6:15 AM**.
- Turn the Rotary Dial until **ON/OFF / MON YES** is displayed and push **ON/OFF / MON YES**.
- Turn the dial until **ON/OFF / SUN YES** is displayed and push **ON/OFF / SUN YES**.
- Turn the dial until display shows **ON/OFF / SUN NO** and push to confirm **CONFIRMED ✓** and then **ON/OFF / SUN NO**.
- Turn the dial to **EXIT** and push. The display shows **ON/OFF / MON YES**.
- Turn the dial to **EXIT** and push. **COFFEE READY**.

14.6 AUTO-OFF

The S9 OT is pre-set to turn itself off 5 hours after last use. You can change the auto-off interval between 0.5 and 15 hours or you can set the machine not to turn itself off.

Recommendations: If you only use the machine in the morning, change the auto-off to 2 hours. If you use the machine all day long, leave the auto/off as is. This way the machine is always ready, and it is not necessary to turn it on and to warm up.

Example:

Change the auto-off from 5 hours to 2 hours after last use.

COFFEE READY.

- Push the Rotary Dial until the display shows **MAINTENANCE**.
- Turn the Dial until the display shows **OFF AFTER 5 H**.
- Push the Dial **OFF AFTER 5 H**.
- Turn the dial until display show **OFF AFTER 2 H** and push to confirm. **CONFIRMED ✓**, **OFF AFTER 2 H**.
- Turn the dial to **EXIT** and push. **COFFEE READY**.

14.7 RINSE SETTINGS

This program allows you to change both the Rinse cycle and the Cappuccino Rinse cycle.

Rinse cycle (INIT RINSE)

After turning the machine on with the On/Off button, the S9 OT heats up and then prompts you to run a short rinse cycle (chapter 8). You can re-program this function so that this rinse cycle is done automatically.

Example:

Change the initial rinse cycle from manual to automatic:

COFFEE READY.

- Push the Rotary Dial until the display shows **MAINTENANCE**.
- Turn the Dial until the display shows **RINSES** and push the dial. **INIT RINSE MANUAL**.
- Push the dial again, **INIT RINSE MANUAL** and turn to **INIT RINSE AUTO** and push to confirm. **CONFIRMED ✓** then **INIT RINSE AUTO**.
- Turn the dial to **EXIT** and push the dial **RINSES**.
- Turn the dial to **EXIT** and push **COFFEE READY**.

CAUTION / WARNING

In the setting **INIT RINSE AUTO** the machine will automatically dispense hot water through the Dual Coffee Spouts. Please keep children and pets away!

Cappuccino rinse cycle (**CAPP RINSE**)

The S9 OT is factory-set to immediately remind you to run a rinse cycle after milk use (chapter 10g). This function can be re-programmed to remind you 10 minutes after last milk use.

14.8 INFORMATION

In this program you can look up

- how many coffees you produced with the individual beverage buttons,
- how often cleaning, filter change and descaling programs were performed,
- how close to the next tablet cleaning program, etc.

14.9 DISPLAY SETTINGS (**SETTING AM/PM / OZ**)

This function lets you select the time format **AM/PM** or **24HR** format and the volume either in ounces **OZ** or milliliters **ML**.

COFFEE READY

- Push the Rotary Dial until the display shows **MAINTENANCE**.
- Turn the Dial until the display shows **DISPLAY AM/PM / OZ**.
- Push and turn the Dial to change the time display and push the dial to confirm.
- Turn Dial to change from **OZ** to **ML** and push to confirm.
- Turn the Dial to **EXIT** and push to return to **COFFEE READY**.

14.10 LANGUAGES

You can change the display from English to French, Portuguese, German, Italian, Dutch or Spanish.

COFFEE READY

- Push the Rotary Dial until the display shows **MAINTENANCE**.
- Turn the Dial until the display shows **LANGUAGE ENGLISH**.
- Push and turn the Dial until the desired language appears and push to confirm.
- Turn the Dial to **EXIT** (in the language you choose).
- Push the Dial to get back to **COFFEE READY** (in the language you choose).

15. CARE AND MAINTENANCE MESSAGES

The machine will automatically display messages. In some cases the message allows you to continue to brew coffee. In other cases no further coffee brewing is possible before the task has been completed.

PRESS RINSE

Push the Rinse button (Fig. 2,E). The machine pumps hot water through the coffee spouts or continues a cleaning program.

FILL SYSTEM / PRESS RINSE

Place containers underneath the Auto Cappuccino System and the Hot Water Spout (Fig. 4) and push the Rinse button (chapter 6c).

FILL WATER TANK

The water tank is almost empty. Add water before resuming brewing coffee.

EMPTY GROUNDS or **EMPTY TRAY**

The used coffee container is full (it holds a maximum of 16 coffee portions). You must empty the coffee container before you

can resume brewing coffee.

Make sure the Dual Coffee Spouts are moved upwards. Carefully lift and pull out the removable drawer (Fig. 18 and 19). **TRAY MISSING**. There is water in the drawer. Empty the drawer and the used coffee container, assemble and replace. Make sure the two metal contacts of the drawer are clean and dry.

Please note: If the machine is not used for a few days, pull out the tray and empty the used coffee container. Used, moist coffee grounds can develop mold and mildew.

Important: If you pull out the drawer without any corresponding message in the display you must empty the used coffee container. The machine assumes that it will be emptied. If you do not empty the container, used coffee will overflow inside the machine and cause serious damage to the coffee release mechanism.

Please note: The machine does not sense if the used coffee container (Fig. 1,16) is inserted. If the used coffee container is not inserted, ground coffee discharges onto the drawer.

TRAY MISSING

Insert the drawer with the empty used coffee container. Make sure the metal contacts in the back of the drawer are clean and dry.

FILL BEANS

Add beans to the bean container.

COFFEE READY / CLEAN MACHINE

After approx. 220 coffee brewings or 80 initial rinsing cycles you must run a tablet cleaning cycle. You can still make coffee, however we highly recommend to perform the cleaning cycle within the next few days (chapter 16.1).

COFFEE READY / CLEAN NOW

After 30 more coffee brewings the message reads **CLEAN NOW**.

COFFEE READY / DECALCIFY MACHINE

It is time to decalcify the machine. You can still make coffee, however we highly recommend to perform the decalcifying cycle within the next few days (chapter 17.1).

Please note: If you use the Clearyl cartridge and the message appears, then your cartridge function was not activated. Follow the instruction in chapter 13a to program and activate the cartridge. If the cartridge is already in use for several weeks install a new cartridge.

COFFEE READY / DECALCIFY NOW

It is urgent to decalcify the machine.

COFFEE READY / CHANGE FILTER

It is time to replace the Clearyl filter (chapter 13b).

NOT ENOUGH PRE-GROUND

Not enough pre-ground coffee was filled into the ground coffee funnel (Fig. 1,11). The S9 OT stops the operation (chapter 9e).

15.1 MANUAL MAINTENANCE CYCLES

The S9 OT will display when it's time to perform certain cleaning programs. You can also manually access these programs and perform them.

COFFEE READY.

- Push the Rotary Dial until the display shows **MAINTENANCE**.
- Push the Dial again, **CLEAN CAPPUCCINO**.
- Turning the dial shows you which programs you can access:

CLEAN CAPPUCCINO (chapter 15.5)

RINSE MACHINE (see example below in chapter 15.1)

RINSE CAPPUCCINO (chapter 10g)

CLEAN MACHINE (chapter 16.1)

DECALCIFY MACHINE (chapter 17.1)

CHANGE FILTER (chapter 13c)

If you push the Rotary Dial to enter one of the above programs, the display guides you through the necessary steps.

Please note: If the display shows **MAINTENANCE** and you do not select one of the above programs within five seconds, the S9 OT will return to **COFFEE READY**.

Example:

Run a manual hot water rinse cycle. **COFFEE READY**.

- Push the Rotary Dial until the display shows **MAINTENANCE**.
- Push the Dial again, **CLEAN CAPPUCCINO**.
- Turn the Dial until the display shows **RINSE MACHINE**.
- Place a cup under the Dual Coffee Spouts.
- Push the Rotary Dial. The S9 OT will push hot water through the Dual Coffee Spouts and then return to **COFFEE READY**.

15.2 REMOVING STONES FROM THE BURR GRINDER

If the burr grinder is blocked, proceed as follows:

- Turn off the machine by pushing the ON/OFF button (Fig. 2,B). Wait until the machine has shut down completely.
- Turn the main power switch off (Fig 1b).
- Open the bean container lid and remove all beans (scoop out beans or use a hand-held vacuum cleaner).
- Remove the screw in the bean container (Fig. 23) and push the grinder shield upwards (Fig. 24) Do not try to remove the shield completely.
- If any beans remain, remove them.
- Attach the burr grinder release tool (in Welcome Pack) to the upper burr (Fig. 25).
- If you cannot find this tool call 1-800-220-5701 and we will send the tool to you free of charge.

- Turn the tool counter-clockwise slowly until the stone becomes loose.

Attention: Do not try to turn the tool clockwise.

- Fold the shield down and replace the screw.
- Turn machine on and test the grinder without beans to see if the blockage has disappeared.

15.3 GENERAL CLEANING INSTRUCTIONS

Never use abrasive materials or chemicals to clean the machine.

- Clean the housing with a soft, damp cloth.
- Rinse water tank daily and fill with fresh cold water.

15.4 EMPTYING THE SYSTEM BEFORE TRANSPORT

This procedure is necessary to prevent water and frost damage in case you intend to transport the machine.

COFFEE READY

- Place a container under the Cappuccino system and the Hot Water Spout.
- Turn the machine off. The main power switch is still on.
- Press and hold the Rinse button until the display shows **SYSTEM EMPTYING**
- A small amount of water is dispensed. When the process is completed the machine turns itself off.

The next time the machine is turned on, the display shows **FILL SYSTEM/PRESS STEAM** (chapter 6c).

15.5 CLEANING THE FROTHXPRESS

After frothing a few drops of milk remain inside the frothXpress. The S9 OT displays **RINSE CAPPUCCINO**. Follow the instructions in chapter 10g.

If you use the frothXpress extensively or forgot to clean it, milk fat starts building up inside the frothXpress. In this case use the Cappuccino Cleaner liquid in the Welcome Pack.

Run a **CLEAN CAPPUCCINO** cycle as follows:

COFFEE READY.

- Push the Rotary Dial until the display shows **MAINTENANCE**.
- Push the Dial again, **CLEAN CAPPUCCINO**.
- Push the Dial again. **CLEANER FOR CAPPU**. The Rinse button illuminates.
- Pour approx. 5 oz. of water into a container and add one capful (15 ml or 1/2oz.) of the Cappuccino Cleaner liquid.
- Immerse one end of the long milk hose into the cleaning solution and insert the other end into the frothXpress. Turn the frothXpress Dial to the 12 o'clock position.
- Place a container under the frothXpress (Fig. 4).
- Push the rinse button. **CAPPUCCINO CLEANS**. The S9 OT siphons the cleaning solution through the frothXpress and stops automatically.
- When the display shows **WATER FOR CAPPUCCINO**, remove both containers and empty. Fill fresh water into one container and insert the hose again. Place the other empty container under the frothXpress.
- Push the Rinse button again. **CAPPUCCINO CLEANS**. The S9 OT will siphon fresh water through the frothXpress, removing the cleaning solution. **COFFEE READY**.
- Squeeze the bottom of the venting tip (Fig. 17a) to make sure it is clean.

You can also immerse the frothXpress parts (except the chrome plated face) into a cappuccino cleaner solution as follows:

- Remove the frothXpress from the steam nozzle.
- Take the frothXpress apart (Fig. 17a) and set the chrome plated face aside.
- Place all parts other parts including the hose in a cup with warm water and add one cap-full (15 ml or 1/2oz.) of the cappuccino liquid.
- Let sit for ten minutes or overnight.
- Rinse all parts under fresh water and assemble.

16. AUTOMATIC CLEANING CYCLES

16.1 CLEANING WITH SPECIAL TABLET

The machine monitors how many coffees are brewed and how often the rinsing program is activated. After approx. 220 coffees the display shows **COFFEE READY / CLEAN MACHINE**. You can continue brewing coffee, however we highly recommend that you clean the machine as described below within the next few days. This cleaning program will remove oil build-ups in the brewing chamber. If the display shows **CLEAN NOW** clean the machine immediately.

This cleaning program takes about 20 minutes. Please use the enclosed white cleaning tablet. The machine comes with a pack of 2 tablets. To re-order see chapter 20.

Important: Once the cleaning program has started do not interrupt the procedure.

COFFEE READY / CLEAN MACHINE

1. Push the Rinse button. **DURATION 20 MIN. / START YES**.
Please note: To clean the S9 OT at a later time, turn the Rotary Dial until the display shows **START NO**. Push the Rotary Dial to

exit the program. In this case the S9 OT will remind you with the message **CLEAN MACHINE**.

2. Make sure that the water container is at least half full.
3. Push the Rinse Button. **EMPTY TRAY**.
4. Remove and empty the tray and the used coffee container and replace.

Attention: If the tray and the used coffee container are already empty, you still need to remove the tray for approx. 20 seconds and then replace it. **PRESS RINSE**.

5. Place containers (20 oz.) under the coffee spout and the frothXpress (Fig. 4) and push the Rinse button (Fig. 2.E). The display shows **CLEANS**. After a short while you will hear a beep and the display shows **ADD TABLET/PRESS RINSE**.
6. Open the ground coffee funnel lid and drop one white tablet into the opening (Fig. 22). Close lid.
7. Push the Rinse button. The display shows **CLEANS**. The machine will start the automatic cleaning program by dispensing water in intervals into the containers underneath the spouts. When finished, the display shows **EMPTY TRAY**.
8. Remove the tray. There will be water in the tray and in the used coffee container. Empty, clean and replace. The display shows **COFFEE READY**.
9. Clean the ground coffee funnel. Remove the funnel and rinse under hot water and dry. Replace funnel (Fig. 20 and 21).

16.2 MANUAL TABLET CLEANING

This program is useful if the brewing process slows down due to excessive oil build-up inside the machine. **COFFEE READY**.

- Push and hold the Rotary Dial. **MAINTENANCE**.
- Push the Rotary Dial, display shows **CLEAN CAPPUCCINO**.

- Turn the dial until the display shows **CLEAN MACHINE** and push the dial. The display shows **DURATION 20 MIN. / START YES**.
- Continue with the steps 2 through 9 from the chapter 16.1.

17. DECALCIFYING

The machine has an integrated decalcifying program. This program takes 45 minutes. When the display shows **COFFEE READY / DECALCIFY MACHINE** it is time to decalcify the machine. The Rinse button is illuminated. You can still make coffee. However, it is highly recommended to decalcify the machine within the next 3 to 4 days.

Please note: If you use the Clearyl water cartridge and the display shows **DECALCIFY MACHINE** then your cartridge function is not activated. Follow the instructions in chapter 13a to activate the Clearyl Cartridge. If the cartridge is in use for several weeks install a new cartridge.

Important: The decalcifying program must not be interrupted.

NOTE: Only use our special, square decalcifying tablets Model # 66281, see chapter 20.

CAUTION: Never use vinegar or any other decalcifying agent. This might damage internal parts of the machine.

CAUTION: Immediately remove any splashes of the decalcifying solution from sensitive surfaces, such as natural stone or wood.

CAUTION: If the decalcifying solution comes in contact with the skin, rinse it off with water. If the solution comes in contact with your eyes, see a doctor.

Important: Always wait until the decalcifying solution in the water tank has been used up. Do not fill additional decalcifying solution into the water tank.

17.1 DECALCIFYING PROCEDURE

COFFEE READY / DECALCIFY MACHINE

1. Push the Rinse button until display shows **DURATION 45 MIN. / START YES.**

Please note: To start at a later time, turn the Rotary Dial to **START NO** and push the Rotary Dial. The machine will still display **COFFEE READY / DECALCIFY MACHINE.**

2. Push the Rinse button again, display shows **EMPTY TRAY.**
3. Remove and empty the tray and the used coffee container and replace, display shows **SOLVENT IN TANK.**

Attention: If the tray and the used coffee container are empty, you must remove the tray for approx. 20 seconds and then replace it.

4. Remove the frothXpress system from the Auto Cappuccino system (Fig. 16).
5. Remove the water container and empty.
6. Completely dissolve 3 of the large square decalcifying tablets in a container with 20 oz. of water (0.6 liters) and pour the solution into the water tank.
7. Replace water tank. **SOLVENT IN TANK/PRESS RINSE**
8. Place containers under the Auto Cappuccino system and the hot water spout (Fig. 4).
9. Push the Rinse button. The display shows **DECALCS** and the light in the Rinse button flashes during the operation. The machine pumps the decalcifying solution in intervals through the Cappuccino system and the hot water spout. The display shows decalcifying status in the progress bar.
10. When display shows **EMPTY TRAY**, remove and empty the containers. Then carefully remove and empty the tray and the used coffee container and replace.

11. Display shows **RINSE WATER TANK / FILL WATER TANK.** Remove the water tank, rinse thoroughly, fill it halfway with fresh water and replace. The display shows **PRESS RINSE.**
12. Place containers under the auto cappuccino system and the hot water spout / coffee spouts (Fig. 4).
13. Push the Rinse button **DECALCS.**
14. The machine pumps fresh water through the system and stops automatically. The display shows **HEATING UP.** When the display shows **MACHINE RINSING**, hot water will flow through the coffee spouts. **EMPTY TRAY.**
15. Remove and empty the containers. Then carefully remove and empty the tray and the used coffee container and replace. **COFFEE READY.**

The machine will automatically remind you when it's time to decalcify again.

17.2 MANUAL DECALCIFYING

If you use very hard water it is possible that calcium builds up prematurely. If your coffee does not come out as hot as before it is a sign for calcium build-up. When this happens you can manually start a decalcifying cycle as follows:

COFFEE READY

- Push the Rotary Dial until the display shows **MAINTENANCE.**
- Push the Rotary Dial, display shows **CLEAN CAPPUCCINO.**
- Turn the dial until the display shows **DECALCIFY MACHINE** and push the dial. The display shows **DURATION 45 MIN. / START YES.**
- Continue with the steps 2 through 15 from the chapter 17.1.

18. TIPS FOR BETTER COFFEE

Height adjustable coffee-spout

Adjust the height of the coffee-spout to the size of your cups.

Grinding

Please refer to chapter 7 "Adjusting the Grinder."

Pre-warm cups

Pre-warm cups in advance with hot water (chapter 9a).

Sugar and cream

Warmth is lost by stirring the contents of the cup. Adding milk or cream from the refrigerator considerably lowers the temperature of the coffee.

19. ERROR MESSAGES / TROUBLESHOOTING

ERROR MESSAGES:

The machine can display any of the following error messages:

ERROR 1, ERROR 3, ERROR 5

Call our customer service hot line 1-800-220-5701.

Your machine needs to be returned for service.

ERROR 2, ERROR 4

Your machine is too cold. The heating sensor does not react.

- Turn the machine off.
- Keep the machine at normal room temperature (65° F or higher) for 2 hours .
- Then turn it on again.

If display still shows **ERROR 2** or **ERROR 4** call customer service.

ERROR 6, ERROR 7, ERROR 8

- Turn machine off, turn the main power switch off and unplug

machine for a minute.

- Turn machine on again. If the error message comes up again, try one more time.
- If the message persists, call customer service.

TROUBLESHOOTING:

A. NO COFFEE COMES OUT OF THE COFFEE SPOUT

Reason: Beans in bean container are not feeding properly into the grinder because they are stuck together.

Solution: Stir beans before grinding and while grinding turn the grinding selector to the coarsest setting.

When using very oily beans pour the beans onto a plate and let some of the sticky oils evaporate (this will not harm the aroma of the coffee).

Reason: You used ground coffee in the ground coffee funnel. The ground coffee was too fine.

Solution: Use ground coffee which is ground somewhat coarser.

Reason: No water is transported through the system.

Solution: Remove water container and make sure that the connecting valve is free of any particles (like a coffee bean etc).

Reason: The ground coffee funnel is clogged; the internal brewing chamber is clogged.

Solution: Place a large cup underneath the coffee spout. Push the rinse button (Fig. 2E) a few times until the blocked coffee is removed. (Never fill more than 2 scoops of coffee in the ground coffee funnel; the funnel is not a storage area for ground coffee). Also, use a ground coffee which is ground somewhat coarser.

B. THE DISPLAY READS "FILL WATER TANK" BUT THERE IS ENOUGH WATER IN THE WATER TANK.

Reason: The floatation device (Fig.1,4) is stuck or missing.

Solution: Clean the water container and make sure the floatation device moves freely.

Solution: Within the water tank is a small compartment (like a mouse trap). Inside is a small black floatation device. On top is a small clear see-through plastic cover. This small plastic cover is missing and the floatation device is outside of the small compartment. Check if you can find both pieces inside the water tank and put it back together. If you cannot find the pieces call 1-800-220-5701. We will send the pieces **FREE OF CHARGE**.

C. INSUFFICIENT FROTHED MILK PRODUCTION

Reason: Milk is initially not cold enough or your milk is not suited for thick frothing.

Solution: Make sure milk is cold. Use a different type of milk. Skim milk will produce the thickest and longest lasting froth. Full fat milk will produce less thick froth.

Reason: The components of the frothXpress are not assembled properly, or the components are clogged with hardened milk, or one or more of the components are missing.

Solution:

- a. Remove frothXpress. Check that steam comes out of the steam nozzle. Place a cup underneath the steam nozzle and use the milk function (chapter 10e). **CAUTION:** hot steam is dispensed from the steam nozzle.
If no steam is released stop the milk function and use a needle to clear blockage inside the steam nozzle.
- b. Clean all frothXpress parts and assemble properly (chapter 15.5).

c. If any parts are missing call: 1-800-220-5701.

D. GRINDER MAKES AN EXTREMELY LOUD NOISE; NO BEANS ARE GROUND

Reason: A stone or object is blocking the burr grinder.

Solution: See chapter 15.2.

E. THE REMOVABLE DRAWER (Fig.1, 18) DOESN'T COME OUT

Reason: The internal used coffee disposal chute did not retract.

Solution: Turn off the machine. Wait a minute. Turn machine on and wait until it stops making any noise. Now try to pull out the drawer. If this does not work, turn the machine off. Now pull the drawer out with some force. You will feel some resistance. When the drawer is out you will see that the back wall of the used coffee container (Fig.1,16) is missing.

Reach into the machine and retrieve the back wall (it is a small black flexible piece). Set the used coffee container aside and insert the drawer (without the used coffee container) into the machine. Turn the machine on. Wait until all noise has stopped. The disposable chute should retract. Remove the drawer, replace the used coffee container and insert it back into the machine. Check if the drawer comes out easily.

20. SUPPLIES

The following supplies are necessary to keep your machine in good working order:

- **Clearyl Water Filter Cartridge** (one included).
Model #64553; the machine will remind you automatically.
Tip: If you brew 10 cups a day you need about one Clearyl cartridge per month. Always keep extra cartridges available.

- **Special Cleaning Tablets** (two included) Model #62205.
Tip: If you brew 10 cups a day you need about one tablet every 3 weeks. Always keep extra tablets available.
- **Auto-Cappuccino Cleaner** (one bottle included).
Model #63801
Tip: If you use the auto cappuccino cleaner every other day you need a new bottle every 5 weeks.
- **Decalcifying tablets** (large square tablets) - Model #66281.
Please note: You must use decalcifying tablets if you do not use the Clearyl cartridge.

You can order these supplies:

- with the enclosed mail order form or
- through our website www.cappresso.com or
- by calling our customer service center at 1-800-220-5701.

21. LIMITED TWO-YEAR WARRANTY

Please note: This warranty will be void if the Warranty / Product Registration has not been received two weeks after the purchase date (you can fax or mail the registration or you can register through our website www.cappresso.com)

This limited warranty covers your new Jura-Cappresso S9 One-Touch Series for two years or up to 6,000 coffee brewings, whichever comes first.

This warranty is in effect for the period and usage described above from the date of the first purchase and is limited to the United States of America. This warranty covers all defects in materials or workmanship (parts and labor) including free UPS ground transportation for both ways within the continental United States. For Hawaii and Alaska freight is not covered by

this warranty.

In case the machine cannot be repaired, JURA-CAPRESSO will replace your machine with the same model with the same or less usage. In case we cannot replace your machine with the same model we will replace it with a model of the same or higher retail value with the same or less usage. Usage is defined by the number of coffees the machine has made when sent for repair.

TRANSPORT: When sending the machine, use the original packing, the inner and outer cartons or use approximately 2" of bubble wrap and insert machine in a carton which will hold 40lbs.

Any damage in transit is NOT covered by this warranty.

THIS WARRANTY DOES NOT COVER:

- Any machine NOT distributed by JURA-CAPRESSO within the United States.
- **Any machine not purchased from an Authorized Jura-Cappresso Dealer.** (Call our customer service department to check for authorized dealers).
- Any machine purchased through EBAY.
- Damage caused by accident, abuse, negligence, misuse,
- improper operation or failure to follow instructions contained in this manual.
- Any service or alteration performed by an unauthorized person, company or association.
- Damage caused by neglecting and omitting maintenance, cleaning and decalcifying cycles.
- Damage caused by use of instant coffee or any other ingredients not allowed in this product.

Other limitations and exclusions:

Any implied warranties including fitness for use and merchantability are limited in duration to the period of the express warranty

set forth above and no person is authorized to assume for JURA-CAPRESSO any other liability in connection with the sale of the machine. JURA-CAPRESSO expressly disclaims liability for incidental and consequential damages caused by the machine. The terms "incidental damages" refer to the loss of the original purchaser's time, loss of the use of the machine or other costs relating to the care and custody of the machine. The terms "consequential damages" refer to the cost of repairing or replacing other property which is damaged when this machine does not work properly. Any loss of income is excluded. The remedies provided under this warranty are exclusive and in lieu of all others. This warranty gives you specific legal rights, and you may also have other rights which vary from state to state.

22. FREE REPAIR SERVICE / EXTRA REPAIR COVERAGE

Within the warranty period all repairs are free of charge including both ways UPS ground transportation to and from our service facilities within the continental United States.

For Hawaii and Alaska freight is not covered by this warranty.

In case the machine cannot be repaired, JURA-CAPRESSO will replace your machine with the same model with the same or less usage. In case we cannot replace your machine with the same model we will replace it with a model of the same or higher retail value with the same or less usage. Usage is defined by the number of coffees the machine has made when sent for repair.

Within four weeks after your product registration you can purchase an extra 12 months of repair coverage. For details see the literature enclosed with this product.

Jura-Capresso Inc.

81 Ruckman Road, Closter, NJ 07624

201-767-3999 • Fax: 201-767-9684

Customer Service: 1-800-220-5701

Email: contact@capresso.com • Website: www.capresso.com