





[www.delonghi.com](http://www.delonghi.com)

Instructions for use. Keep these instructions  
Mode d'emploi. Conservez cette notice  
Instrucciones para el uso. Repase y guarde  
estas instrucciones. Lea cuidadosamente este  
instructivo antes de usar su aparato

## FULLY AUTOMATIC COFFEE CENTER MACHINE À CAFÈ AUTOMATIQUE CAFETERA SUPERAUTOMATICA ESAM6620



Register this product on-line and receive a free trial issue of Cook's Illustrated. Visit [www.delonghiregistration.com](http://www.delonghiregistration.com). Visit [www.delonghiusa.com](http://www.delonghiusa.com) for a list of service centers near you. (U.S. and Canada Only)

Registre este producto en línea y reciba un ejemplar gratis de Cook's Illustrated. Visite [www.delonghiregistration.com](http://www.delonghiregistration.com). Visite [www.delonghiusa.com](http://www.delonghiusa.com) para ver la lista de centros de servicios cercanos a usted. (Solamente en los Estados Unidos y Canada)

Enregistrez ce produit en ligne et recevez un numéro gratuit de Cook's Illustrated. Visitez [www.delonghiregistration.com](http://www.delonghiregistration.com). Visitez [www.delonghiusa.com](http://www.delonghiusa.com) pour y voir une liste des centres de réparation proches de chez vous. (É.-U. et Canada uniquement)

Electronic Characteristics: Caractéristiques électriques: Características electricas:  
120V ~60 HZ 1 350 W

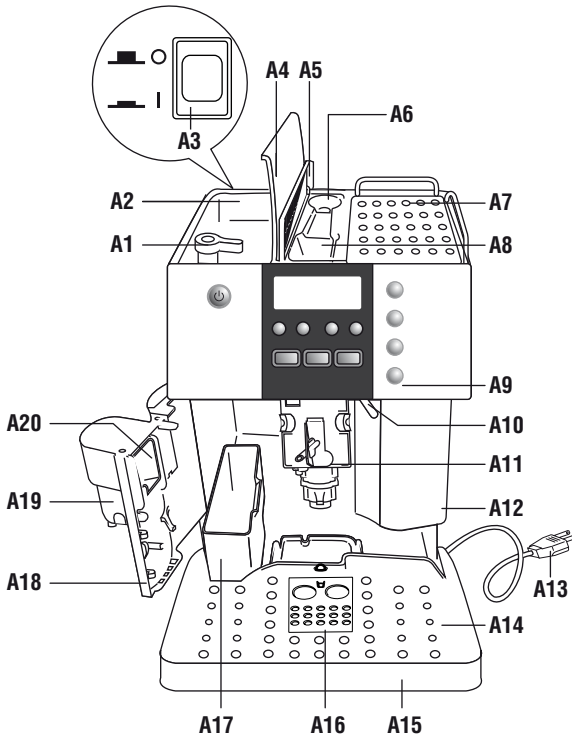
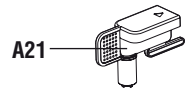
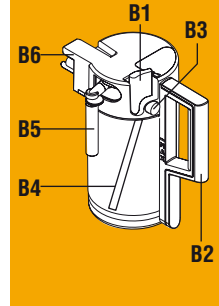
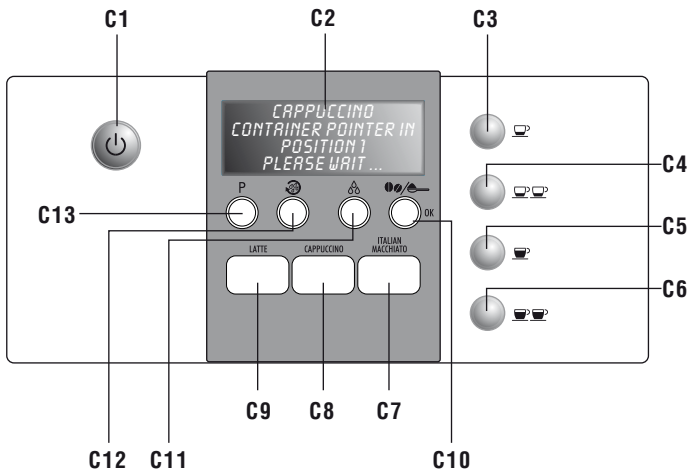

**A****B****C**

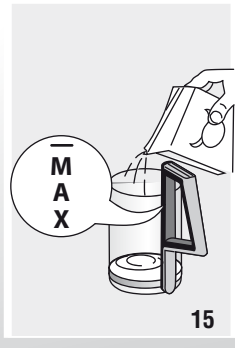
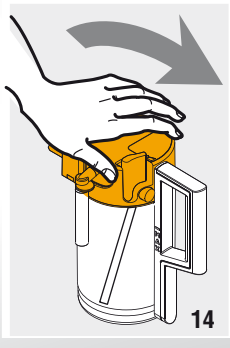
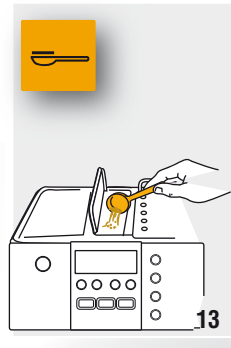
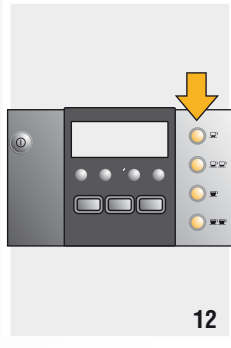
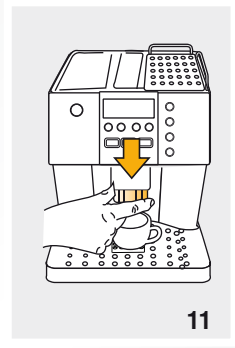
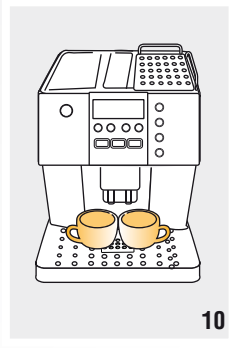
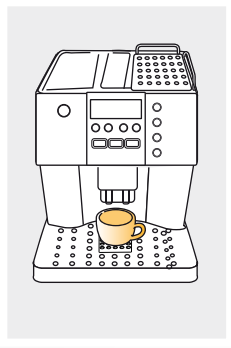
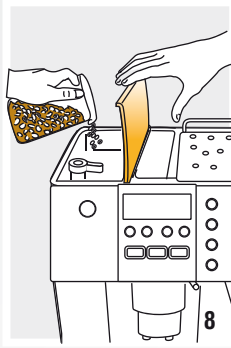
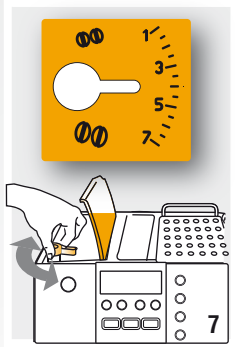
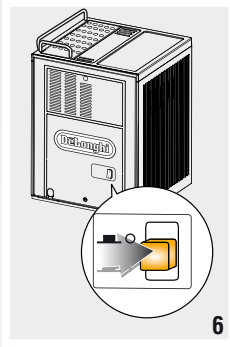
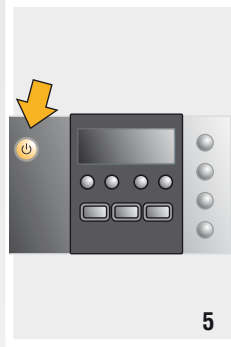
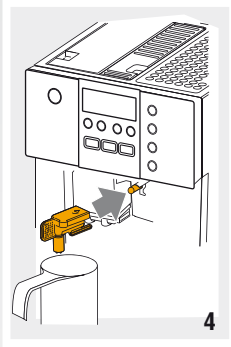
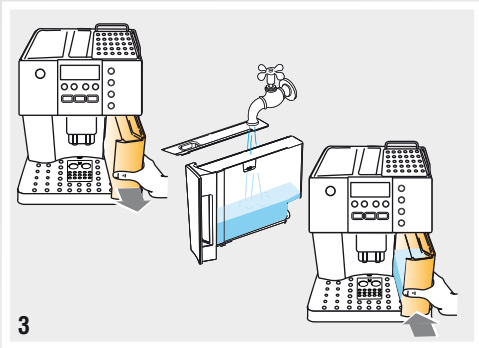
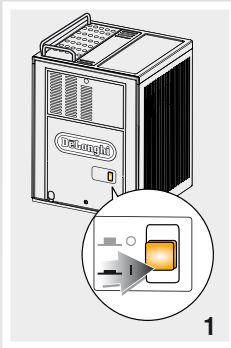

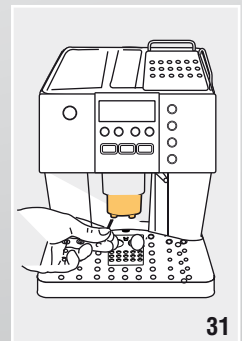
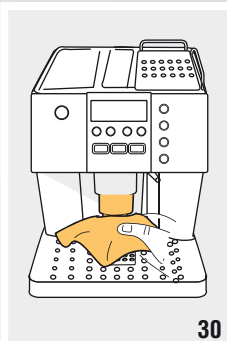
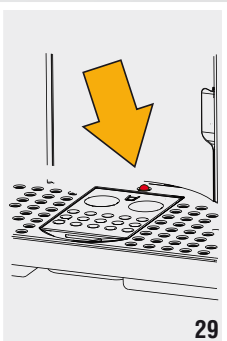
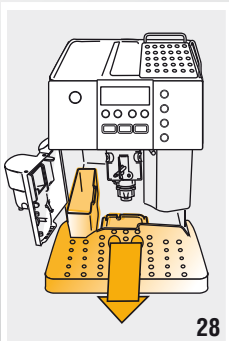
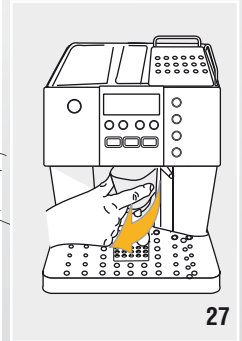
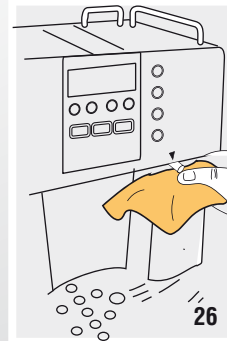
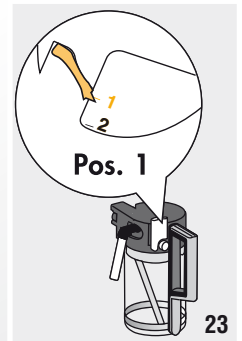
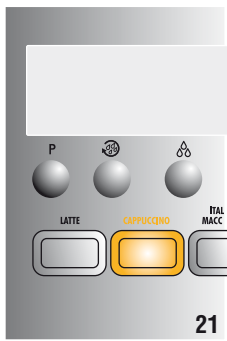
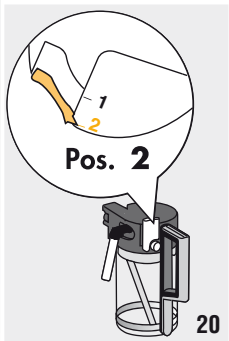
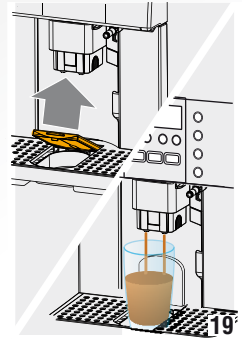
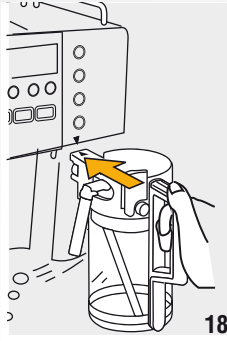
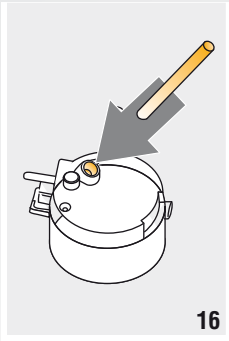

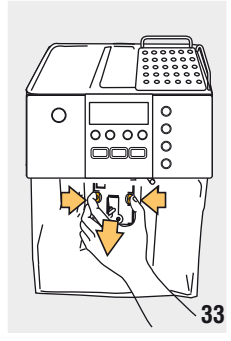
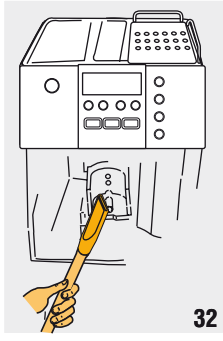



## **CONTENTS**

<b>IMPORTANT SAFEGUARDS</b> .....	<b>8</b>
SAVE THESE INSTRUCTIONS .....	8
<b>SHORT CORD INSTRUCTIONS</b> .....	<b>8</b>
<b>INTRODUCTION</b> .....	<b>9</b>
Symbols used in these instructions .....	9
Letters in brackets .....	9
Troubleshooting and repairs .....	9
<b>DESCRIPTION OF THE APPLIANCE</b> .....	<b>9</b>
Description of the appliance .....	9
Description of milk container .....	9
Description of control panel .....	9
<b>PRELIMINARY CHECKS</b> .....	<b>10</b>
Checking the appliance .....	10
Installing the appliance .....	10
Connecting the appliance .....	10
Using the appliance for the first time .....	10
<b>TURNING THE APPLIANCE ON</b> .....	<b>11</b>
<b>TURNING THE APPLIANCE OFF</b> .....	<b>11</b>
<b>CHANGING THE MENU SETTINGS</b> .....	<b>11</b>
Energy Saving .....	11
Setting the clock .....	11
Setting auto-start time .....	12
Activating auto-start .....	12
Descale .....	12
Setting the temperature .....	12
Auto-Off .....	12
Setting water hardness .....	12
Default values (reset) .....	12
Beep ON/OFF (activates and deactivates the beep) .....	13
<b>MAKING COFFEE</b> .....	<b>13</b>
Selecting the coffee taste .....	13
Selecting the quantity of coffee in the cup .....	13
Adjusting the coffee grinder .....	13
Manual rinsing .....	13
Making espresso coffee using coffee beans .....	14
Making coffee using pre-ground coffee .....	14
<b>MAKING DRINKS WITH MILK</b> .....	<b>14</b>
Filling and attaching the milk container .....	14
Making cappuccino .....	15
Making Italian macchiato .....	15
Making latte .....	15
Making frothed milk and hot milk (WITHOUT COFFEE) .....	15
Cleaning the milk container after use .....	15
Programming the quantities of coffee and milk in the cup .....	15

<b>HEATING WATER</b> .....	<b>16</b>
Preparation .....	16
Changing the quantity .....	16
<b>CLEANING</b> .....	<b>16</b>
Cleaning the coffee maker .....	16
Cleaning the coffee grounds container .....	16
Cleaning the drip tray .....	17
Cleaning the water tank .....	17
Cleaning the coffee spouts .....	17
Cleaning the pre-ground coffee funnel .....	17
Cleaning the inside of the coffee maker .....	17
Cleaning the infuser .....	17
Cleaning the milk container .....	18
<b>DESCALE</b> .....	<b>18</b>
<b>SETTING WATER HARDNESS</b> .....	<b>19</b>
Measuring water hardness .....	19
Set water hardness .....	19
<b>SETTING THE LANGUAGE</b> .....	<b>19</b>
<b>TECHNICAL SPECIFICATION</b> .....	<b>19</b>
<b>DISPLAYED MESSAGES</b> .....	<b>20</b>
<b>TROUBLESHOOTING</b> .....	<b>21</b>
<b>LIMITED WARRANTY</b> .....	<b>23</b>
What does the warranty cover? .....	23
How long does the coverage last? .....	23
What is not covered by the warranty? .....	23
How do you get service? .....	23
How does state law apply? .....	23

# IMPORTANT SAFEGUARDS

When using electrical appliances, basic safety precautions should always be followed, including the following.

- Read all instructions carefully.
- Make sure the voltage of your electrical system corresponds to the voltage shown on the bottom of the machine.
- Do not touch hot surfaces. Use handles or knobs.
- To protect against fire, electrical shock and personal injury, do not immerse cord, plug or appliance in water or other liquid.
- Keep the appliance out of the reach of children and do not leave appliance unattended while in operation.
- Unplug from the outlet when not in use and before cleaning.
- Do not operate with a damaged cord or plug, or after the appliance malfunctions, or has been damaged in any manner. Return the appliance to the nearest authorized service facility for examination, repair or adjustment.
- The use of accessory attachments not recommended by the manufacturer may result in fire, electrical shock, or personal injury.
- Do not use outdoors.
- Make sure the power cord does not hang over the edge of the table or counter-top to avoid getting accidentally caught or entangled.
- Do not place the appliance or its electrical parts on or near electric stoves, cooking surfaces, or gas burners.
- Plug cord into the wall outlet. To disconnect, first turn machine "off", then remove plug from wall outlet.
- Do not use the appliance for other than the intended use. This appliance is to be utilized for domestic use only. The manufacturer declines all responsibility for any damage caused by improper, incorrect, or irresponsible use.

**WARNING: To reduce the risk of fire or electric shock, do not remove the cover or the exterior of the unit. Don't attempt to repair or modify the machine, doing so will void the warranty. Repair should be done by authorized service personnel only!**

## SAVE THESE INSTRUCTIONS

THIS APPLIANCE IS FOR HOUSEHOLD USE ONLY

## SHORT CORD INSTRUCTIONS

A short power cord is provided to reduce risks resulting from becoming entangled in or tripping over a longer cord.

- Longer, detachable power supply cords or extension cords are available and may be used if care is exercised in their use.
- If an extension cord is used, the marked electrical rating should be at least as great as the electrical rating of the appliance. If the appliance is provided with 3- wire, grounding type cord, the extension should be a GROUNDING TYPE 3 - WIRE CORD. The longer cord should be arranged so that it will not drape over the counter-top or table top where it can be pulled on by children or tripped over.
- Your product is equipped with a polarized alternating current line plug (a plug having one blade wider than the other). This plug will fit into the power outlet only one way. This is a safety feature. If you are unable to insert the plug fully into the outlet, try reversing the plug. If the plug should still fail to fit, contact your electrician to replace your obsolete outlet. Do not defeat the safety purpose of the polarized plug.

## INTRODUCTION

Thank you for choosing the ESAM 6620 automatic coffee and cappuccino maker.

We hope you enjoy using your new appliance.

Take a few minutes to read these instructions.

This will avoid all risks and damage to the machine.

### Symbols used in these instructions

Important warnings are identified by these symbols. These warnings must absolutely be respected.



#### **Danger!**

Failure to observe the warning could result in possible life threatening injury from electric shock.



#### **Important!**

Failure to observe the warning could result in injury or damage to the appliance.



#### **Danger of burns!**

Failure to observe the warning could result in scalds or burns.



#### **Please note:**

This symbol identifies important advice or information for the user.

### Letters in brackets

The letters in brackets refer to the legend in the Description of the Appliance on page 3.

### Troubleshooting and repairs

In the event of problems, first try and resolve them following the information given in the section “Displayed messages” on page 20 and “Troubleshooting” on page 21.

If this does not resolve the problem or you require further information, you should consult Customer Services by calling the number given on the annexed “Customer Service” sheet.

If your country is not among those listed on the sheet, call the number given in the guarantee.

If repairs are required, contact De’Longhi Customer Services only.

The addresses are given in the guarantee certificate provided with the appliance.

## DESCRIPTION OF THE APPLIANCE

### Description of the appliance

(page 3 - **A**)

- A1. Grinding adjustment knob
- A2. Beans container
- A3. Main switch
- A4. Beans container lid
- A5. Cover for funnel and measure compartment
- A6. Compartment for measure
- A7. Cup shelf (cup warmer active when Energy Saving is disabled)
- A8. Pre-ground coffee funnel
- A9. Control panel
- A10. Hot water and steam nozzle
- A11. Infuser
- A12. Water tank
- A13. Power cable
- A14. Cup tray
- A15. Drip tray
- A16. Compartment for latte glass
- A17. Grounds tray
- A18. Service door
- A19. Coffee spout (adjustable height)
- A20. Coffee guide
- A21. Hot water spout
- A22. Measure

### Description of milk container





(page 3 - **B**)

- B1. Froth regulator
- B2. Milk container handle
- B3. CLEAN button
- B4. Milk intake tube
- B5. Frothed milk spout
- B6. Lid with milk frother

### Description of control panel

(page 3 - **C**)

*A number of buttons on the panel have a double function. This is indicated in brackets in the description.*

- C1.  ON/STAND-BY button
- C2. Display
- C3.  1 short coffee button
- C4.  2 short coffees button
- C5.  1 long coffee button
- C6.  2 long coffees button
- C7. ITALIAN MACCHIATO button: delivers 1 ITALIAN MACCHIATO (or frothed milk if

- pressed twice consecutively)
- C8. CAPPUCCINO button: delivers 1 CAPPUCCINO (or frothed milk if pressed twice consecutively)
- C9. LATTE button: delivers 1 LATTE (or hot milk if pressed twice consecutively)
- C10.  Button to select coffee taste or use pre-ground coffee. (*OK button to confirm changes to menu settings*)
- C11.  Hot water button. (*SET button to change menu settings*)
- C12.  Rinse button. (*> button to change menu settings*).
- C13. P button to access and escape the menu.

## PRELIMINARY CHECKS

### Checking the appliance

After removing the packaging, make sure the product is complete and undamaged and that all accessories are present.

Do not use the appliance if it is visibly damaged. Contact De'Longhi Customer Services.

### Installing the appliance

#### **Important!**

When you install the appliance, you should respect the following safety warnings:

- The appliance gives off heat. After positioning the appliance on the work top, leave a space of at least 3 cm between the surfaces of the appliance and the side and rear walls and at least 15 cm above the coffee maker.
- Water penetrating the appliance could cause damage. Do not place the appliance near taps or sinks.
- The appliance could be damaged if the water it contains freezes. Do not install the appliance in a room where the temperature could drop below freezing point.
- Arrange the power cable in such a way that it cannot be damaged by sharp edges or contact with hot surfaces (e.g. electric hot plates).

### Connecting the appliance

#### **Important!**

Check that the mains power supply voltage corresponds to the value indicated on the rating

plate on the bottom of the appliance.

Connect the appliance to an efficiently earthed and correctly installed socket with a minimum current rating of 10A only.

If the power socket does not match the plug on the appliance, have the socket replaced with a suitable type by a qualified professional.

### Using the appliance for the first time

#### **Please note:**

- Coffee has been used to factory test the appliance and it is therefore completely normal for there to be traces of coffee in the grinder. The machine is, however, guaranteed to be new.
- You should customise water hardness as soon as possible following the instructions in the section "Setting water hardness" on page 19.

1. Plug the appliance into the mains socket and place the main switch on the back of the appliance in the I position (fig. 1).

You must first choose the language (the languages scroll through at intervals of about 3 seconds).

2. When English appears, press and hold the OK button for 3 seconds (fig. 2). Once the language has been saved, the message "ENGLISH SET" is displayed.

Follow the instructions indicated by the appliance:

3. "FILL TANK!": remove the water tank, fill to the MAX line with fresh water then replace in the appliance (fig. 3).
4. "INSERT WATER SPOUT AND PRESS OK": Check that the hot water spout is inserted on the nozzle and place a container underneath (fig. 4).
5. Press the **OK** button (fig. 2). "PLEASE WAIT..." is displayed and the appliance begins to deliver water.
6. The appliance ends the first start up procedure, then the message "TURNING OFF PLEASE WAIT..." is displayed and the appliance goes off.

The coffee maker is now ready for normal use.

**i Please note:**

When using the appliance for the first time, you need to make 4-5 cups of coffee or 4-5 cappuccinos before the appliance starts to give satisfactory results.

## TURNING THE APPLIANCE ON

**i Please note:**

Before turning the appliance on, make sure the main switch at the back of the appliance is in the I position (fig. 1).

Each time the appliance is turned on, it performs an automatic preheat and rinse cycle which cannot be interrupted.

The appliance is ready for use only after completion of this cycle.

**⚠ Danger of burns!**

During rinsing, a little hot water flows from the coffee spouts and is collected in the drip tray. Avoid contact with splashes of water.

- To turn the appliance on, press the  button (fig. 5). The message “HEATING UP PLEASE WAIT” is displayed.

After heating, the message “RINSING...” is displayed. As well as heating the boiler, the appliance also heats the internal circuits by circulating hot water.

The appliance is at temperature when the message “READY” is displayed.

## TURNING THE APPLIANCE OFF

Each time the appliance is turned off, it performs an automatic rinse cycle which cannot be interrupted.

**⚠ Danger of burns!**

During rinsing, a little hot water flows from the coffee spouts. Avoid contact with splashes of water.

To turn the appliance off, press the  button (fig. 5). The appliance performs the rinse cycle then goes off.

**i Please note:**

If the appliance is not used for an extended

period, place the main switch on the back of the appliance in the 0 position (fig. 6).



## CHANGING THE MENU SETTINGS

Press the **P** button to access the programming menu. The following items can be selected: Clock, Auto-start, Auto-start time, Descale, Temperature, Auto-off, Water hardness, Default values, Beep ON/OFF, Energy saving.

### Energy Saving

Use this function to enable or disable energy saving mode.

When enabled, the function reduces energy consumption.

- Press the **P** button.
- Press the  button (corresponding to the > symbol flashing on the display) repeatedly until the menu arrow is on “ENERGY SAVING”.
- Press the  button (corresponding to the SET symbol flashing on the display) to modify the function (the appliance displays ENERGY SAVING YES or ENERGY SAVING NO);
- Press the **OK** button to confirm the function;
- Press the **P** icon to exit the menu.

When the function is enabled, if the appliance is not used for about 1 minute, “Energy Saving” is displayed.

**i Please note:**

- A few seconds may elapse between “Energy Saving” mode and delivery of the first drink. This is indicated by the display of the message “Preparation in progress”.
- When “Energy Saving” is disabled, the appliance turns the cup warmer on automatically.

### Setting the clock

To set the time displayed, proceed as follows:



- Press the **P** button.
- Press the  button (corresponding to the SET symbol flashing on the display) to set the time on the clock. (If you hold the button down, the time changes rapidly).
- Press the **OK** button to confirm;
- Press the **P** button (corresponding to the ESC symbol flashing on the display) to exit programming mode or > to change other parameters.

**i Please note:**



to display the time with the appliance off, press any button. The time will be displayed for 5 seconds.

### Setting auto-start time

You can set the auto-start time in order to have the appliance ready at a certain time (for example in the morning) so you can make coffee immediately.

- Make sure the clock on the appliance has been set as described in the previous section.
- Press the **P** button, then press the  button (corresponding to the > symbol flashing on the display) repeatedly until the menu arrow is on "START".
- Press the  button (corresponding to the SET symbol flashing on the display) to set the auto-start time. (If you hold the SET button down, the time changes rapidly).
- Press the **OK** button to confirm.

### Activating auto-start

- Press the **SET** button again and "AUTO-START NO" is displayed.
- Press the  button (corresponding to the SET symbol flashing on the display) to modify the function (the appliance displays AUTO-START YES);
- Press the **OK** button to activate auto-start;
- Press the **P** button (corresponding to the ESC symbol flashing on the display) to exit programming mode or  to change other parameters.

**i Please note:**

When the auto-start time is set, the  symbol appears alongside the time on the display.



### Descalc

For instructions on descaling, see page 18.

### Setting the temperature

To modify the temperature (low, medium, high) of the water used to make the coffee, proceed as follows:



- Press the **P** button, then press the  button (corresponding to the > symbol flashing on the display) repeatedly until the menu arrow is on "TEMPERATURE".

- Press the  button (corresponding to the SET symbol flashing on the display) until the appliance displays the required coffee temperature (low, medium, high);
- Press the **OK** button to confirm the temperature selected;
- Press the **P** button (corresponding to the ESC symbol flashing on the display) to exit programming mode or  to change other parameters.

### Auto-Off

The appliance is set to switch automatically to stand-by if not used for 3 hours.

The time can be changed so that the appliance switches off after 1, 2 or 3 hours.



- Press the **P** button, then press the  button (corresponding to the > symbol flashing on the display) repeatedly until the menu arrow is on "OFF AFTER 3 HOURS".
- Press the  button (corresponding to the SET symbol flashing on the display) to change the number of hours the appliance remains on.
- Press the **OK** button to confirm.
- Press the **P** button (corresponding to the ESC symbol flashing on the display) to exit programming mode or  to change other parameters.

### Setting water hardness

For instructions on setting water hardness, see 37.

### Default values (reset)



This resets all menu settings and programmed quantities back to the default values (with the exception of the language which remains as set).

- Press the **P** button, then press the  button (corresponding to the > symbol flashing on the display) repeatedly until the menu arrow is on "DEFAULT VALUES NO"
- Press the  button (corresponding to the SET symbol flashing on the display) and the appliance will display "DEFAULT VALUES YES";
- Press the **OK** button to reset the default values;
- Press the **P** button (corresponding to the

**ESC** symbol flashing on the display) to exit programming mode or  to change other parameters.

The appliance is now reset to the default settings and the “READY” message is displayed.

### Beep ON/OFF (activates and deactivates the beep)

- Press the **P** button, then press the  button (corresponding to the > symbol flashing on the display) repeatedly until the menu arrow is on “BEEP ON”.
- Press the  button (corresponding to the **SET** symbol flashing on the display) and the appliance will display “BEEP OFF”
- Press the **OK** button to turn the beep off;
- Press the **P** button (corresponding to the ESC symbol flashing on the display) to exit programming mode or  to change other parameters.
- The appliance is now set not to emit any Beep and displays the message “READY”.

## MAKING COFFEE

### Selecting the coffee taste

The appliance is preset to make coffee with a standard taste.





You can choose between 5 different coffee tastes:

- Extra-mild taste
- Mild taste
- Standard taste
- Strong taste
- Extra-strong taste

To change the taste, press the  button (fig. 2) repeatedly until the required taste is displayed.

### Selecting the quantity of coffee in the cup

The appliance is set by default to automatically make the following quantities of coffee:

- short coffee when the  button is pressed;
- long coffee when the  button is pressed;
- two short coffees when the  button is pressed;
- two long coffees when the  button is pressed.

To change the quantity of coffee the appliance delivers automatically into the cup, proceed as

described below.

- press the button corresponding to the quantity you want to change for at least 8 seconds until the message “PROGRAM QUANTITY” is displayed and coffee delivery commences;
- when the coffee in the cup reaches the required level, press the same button again to memorise the new amount. This is confirmed by two beeps.

The appliance is now reprogrammed with the new settings and the message “READY” is displayed.

 **Please note:**

all four coffee buttons can be customised.

### Adjusting the coffee grinder

The coffee grinder is preset in the factory to make coffee correctly and should not require adjusting initially.

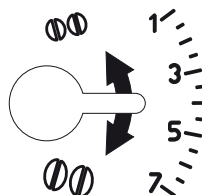

However, if after making the first few coffees you find that delivery is either too fast or too slow (a drop at a time), this can be corrected by adjusting the grinding adjustment knob (fig. 7).

 **Important!**

The grinding adjustment knob must only be turned when the coffee grinder is in operation.

For slower coffee delivery and a creamier coffee, turn one click towards “1” (finer pre-ground coffee).

For faster delivery (not a drop at a time), turn one click towards the “7” (coarser ground coffee).

These adjustments will only be evident after at least 2 cups of coffee have been delivered.

If delivery is still too fast or too slow, repeat the correction procedure.

### Manual rinsing

For a hotter coffee, before delivery rinse the appliance through by pressing the  button. Hot water flows out of the coffee spouts and heats the internal circuit of the machine so that the coffee delivered will be hotter.







### **Danger of burns!**

During rinsing, a little hot water flows from the coffee spouts and is collected in the drip tray. Avoid contact with splashes of water.

## **Making espresso coffee using coffee beans**

### **Important!**

Do not use caramelised or candied coffee beans as they could stick to the coffee grinder and make it unusable.

1. Fill the container with coffee beans (fig. 8).
2. Place under the coffee spouts:
  - 1 cup if you want 1 coffee (fig. 9);
  - 2 cups, if you want 2 coffees (fig. 10);
3. Lower the spouts as near as possible to the cup. This makes a creamier coffee (fig. 11).
4. Press the button corresponding to the number of coffees required (one cup   or two cups   ) (fig. 12).
5. Preparation begins.

Once the coffee has been made, the appliance is ready to use again.

### **Please note:**

- While the machine is making coffee, delivery can be interrupted at any moment by pressing one of the coffee buttons.
- At the end of delivery, to increase the quantity of coffee in the cup, just press (within 3 seconds) one of the coffee buttons until the required quantity has been reached.

### **Please note: Tips**

For hotter coffee, you should:

- 1) perform a rinse cycle as described in the section “Manual rinsing”.
- 2) before making coffee, warm the cups by rinsing them with hot water (using the hot water function).

### **Important!**

If the coffee is delivered a drop at a time, too fast and not creamy enough or too cold, read the tips in the “Troubleshooting” section on page 21.

## **Making coffee using pre-ground coffee**

### **Important!**



- Never add pre-ground coffee when the machine is off or it could spread through the inside of the machine and dirty it. This could

damage the appliance.

- Never use more than one level measure or it could dirty the inside of the machine or block the funnel.

### **Please note:**

If you use pre-ground coffee, you can only make one cup of coffee at a time.

1. Press the  button (fig. 2) repeatedly until “PRE-GROUND” flashes on the display.
2. Put one level measure of pre-ground coffee into the funnel (fig. 13).
3. Place a cup under the coffee spouts.
4. Press the 1 cup  or  button (fig. 12).
5. Preparation begins.

After using the machine with pre-ground coffee, to go back to making coffee using beans, deactivate the pre-ground coffee function by pressing the  button again to enable the coffee grinder.

## **MAKING DRINKS WITH MILK**

### **Filling and attaching the milk container**

1. Turn the lid of the milk container clockwise until it becomes noticeably difficult to turn, then remove (fig. 14).
2. Fill the milk container with a sufficient quantity of milk, not exceeding the MAX level marked on the handle (fig. 15).

### **Please note:**

For a richer dense froth, use skimmed or partially skimmed milk at refrigerator temperature (about 5°C). To avoid milk with poor froth or large bubbles, always clean the milk container as described in the section “Cleaning the milk container”.

3. Make sure the milk intake tube is correctly inserted in the bottom of the milk container lid (fig. 16).
4. Replace the milk container lid and turn anticlockwise as far as it will go.
5. Remove the hot water spout from the nozzle (fig. 17).
6. Attach the container to the nozzle and push as far as it will go (fig. 18). The machine emits a beep (if the beep function is active).
7. Place a sufficiently large cup under the coffee spouts and frothed milk spout.



To use particularly tall cups/glasses, raise the lid of the special compartment in the cup tray (fig. 19).

### Making cappuccino

1. After attaching the milk container, position the froth regulator on 2 printed on the milk container lid (fig. 20).

The quality of froth can be adjusted during delivery by moving the pointer slightly towards 1 for a denser froth.

Moving it towards 2 obtains a less dense froth.

2. Press the CAPPUCCINO button (fig. 21). The message “CAPPUCCINO FROTH REGULATOR IN POSITION 2” appears. (After a few seconds, frothed milk flows out of the milk spout into the cup below. Milk delivery stops automatically and coffee delivery begins).

#### **Please note:**

If during delivery you want to stop making milk or coffee, press the **CAPPUCCINO** button.

### Making Italian macchiato

1. After attaching the milk container, position the froth regulator (B1) on 2 (fig. 20) printed on the milk container lid.
2. Press the **ITALIAN MACCHIATO** button (fig. 22). The message “ITALIAN MACCHIATO FROTH REGULATOR IN POSITION 2” appears. After a few seconds, frothed milk flows out of the milk spout into the cup below. Milk delivery stops automatically and coffee delivery begins.

#### **Please note:**

If during delivery you want to stop making milk or coffee, press the **ITALIAN MACCHIATO** button.

### Making latte

1. After attaching the milk container, position the froth regulator on pos. 1 (fig. 23) printed on the milk container lid.
2. Press the **LATTE** button (fig. 24). The message “LATTE FROTH REGULATOR IN POSITION 1” appears. After a few seconds, milk is delivered from the milk spout into the cup below. Milk delivery stops automatically and coffee delivery begins.

#### **Please note:**

If during delivery you want to stop making milk or coffee, press the **LATTE** button.

### Making frothed milk and hot milk (WITHOUT COFFEE)

1. After attaching the milk container, position the froth regulator (B1) according to the quantity of froth you require (pos. 1 = little froth; pos. 2 = abundant froth).
2. Press the CAPPUCCINO, ITALIAN MACCHIATO or LATTE button twice (within 2 seconds).

### Cleaning the milk container after use

#### **Important: Danger of burns**

When cleaning the internal tubes of the milk container, a little hot water leaks out of the frothed milk tube (B5). Avoid contact with splashes of water.

When “PRESS CLEAN” flashes on the display (each time you use a milk function):

1. Leave the milk container in the machine (you do not need to empty it);
2. Place a cup or other recipient under the frothed milk spout.
3. Press the “CLEAN” button (fig. 25) and hold it down for at least 8 seconds. The message “CLEANING...” is displayed.
4. Remove the milk container and always clean the nozzle with a sponge (fig. 26).

#### **Please note:**

- The milk left in the jug can be kept in the refrigerator. The milk should not be left out of the refrigerator for more than 15 minutes.

### Programming the quantities of coffee and milk in the cup

The appliance is set by default to deliver standard quantities.

To change these quantities, proceed as follows:

1. Place a cup under the coffee spouts and milk spout.
2. Press and hold the CAPPUCCINO button (fig. 21) until the message “MILK FOR CAPPUCCINO PROGRAM QUANTITY” is displayed.
3. Release the button. The appliance starts

delivering milk.

- Once the required quantity of milk has been delivered into the cup, press the CAPPUCCINO button again.
- After a few seconds, the appliance starts delivering coffee into the cup and the message "COFFEE FOR CAPPUCCINO PROGRAM QUANTITY" is displayed.
- Once the required quantity of coffee has been delivered into the cup, press the CAPPUCCINO button again. Coffee delivery stops and "ready" appears on the display.

The machine is now reprogrammed with the new quantities.

The quantities of coffee and milk for macchiato and caffelatte can also be programmed.

## HEATING WATER

---



### Preparation



#### **Important! Danger of burns.**

Never leave the machine unsupervised while delivering hot water.

The hot water spout becomes hot while water is being delivered and must be held by the handle only.

- Make sure the hot water spout (B7) is attached correctly (fig. 4).
- Place a container under the spout (as close as possible to avoid splashes).
- Press the  button (fig. 2). The message "HOT WATER..." is displayed.
- Water flows out of the spout. Delivery stops automatically after 250 ml.
- To interrupt delivery of hot water manually, press the  button again.



#### **Important:**

You should not deliver hot water for more than 2 minutes at a time.

### Changing the quantity

The appliance is set by default to automatically deliver 250 ml.

To modify these quantities, proceed as follows:

- Position a container under the spouts.
- Press the  button until the message "HOT WATER PROGRAM QUANTITY" is

displayed.

- When the hot water in the cup reaches the required level, press the  button again. The machine is now reprogrammed with the new quantity.

## CLEANING

---

### Cleaning the coffee maker

The following parts of the machine must be cleaned regularly:

- coffee grounds container (A17),
- drip tray (A15),
- water tank (A12),
- coffee spouts (A19) and hot water nozzle (A10),
- pre-ground coffee funnel (A8),
- inside the machine, accessible after opening the service door (A18),
- infuser (A11),
- milk container (B)



#### **Important!**

- Do not use solvents, abrasive detergents or alcohol to clean the coffee maker. With De'Longhi superautomatic coffee makers, you need not use chemical products to clean the machine. The descaler recommended by De'Longhi is made from natural and completely biodegradable substances.
- None of the components of the appliance can be washed in a dishwasher with the exception of the milk container (B).
- Do not use metal objects to remove encrustations or coffee deposits as they could scratch metal or plastic surfaces.

### Cleaning the coffee grounds container

When "EMPTY GROUNDS CONTAINER!" is displayed, the grounds container must be emptied and cleaned.

Until the grounds container has been cleaned, the appliance continues to display the message and coffee cannot be made.

Even if not full, the empty grounds container message is displayed 72 hours after the last coffee has been prepared. For the 72 hours to be calculated correctly, the machine must never be turned off with the main switch in the 0 position.

To clean (with the machine on):

- open the service door on the front of the appliance (fig. 28), extract the drip tray (fig. 29), empty and clean.
- Empty the grounds container and clean thoroughly to remove all residues left on the bottom.

### **Important!**

When removing the drip tray, the grounds container must be emptied, even if it contains few grounds.

If this is not done, when you make the next coffees, the grounds container may fill up more than expected and clog the machine.

### **Cleaning the drip tray**

#### **Important!**

If the drip tray is not emptied regularly, the water could overflow from the edge and seep inside or around the coffee maker. This could damage the machine, the surface it rests on or the surrounding area.

The drip tray is fitted with a level indicator (red) showing the level of water it contains (fig. 30). Before the indicator protrudes from the cup tray, the drip tray must be emptied and cleaned.

To remove the tray:

1. Open the service door (fig. 28);
2. Remove the drip tray and the grounds container (fig. 29);
3. Empty and wash the drip tray (A15) and grounds container (A17);
4. Remove the drip tray complete with grounds container (A17);
5. Close the service door.

### **Cleaning the water tank**

1. Clean the water tank (A12) regularly (about once a month) with a damp cloth and a little mild washing up liquid.
2. Clean to remove all washing up liquid residues, then rinse the water tank thoroughly.

### **Cleaning the coffee spouts**

1. Clean the spout regularly using a sponge or cloth (fig. 31). Also clean the hot water nozzle (fig. 27).
2. Check regularly that the holes in the coffee

spout are not blocked. If necessary, remove coffee deposits with a toothpick (fig. 31).

### **Cleaning the pre-ground coffee funnel**

- Check regularly (about once a month ) that the pre-ground coffee funnel is not blocked. If necessary, remove coffee deposits with a knife.

### **Danger of electric shock!**

Before performing any cleaning operations, the machine must be turned off and disconnected from the mains power supply.

Never immerse the coffee maker in water.

### **Cleaning the inside of the coffee maker**

1. Check regularly (about once a week) that the inside of the appliance is not dirty. If necessary, remove coffee deposits with a knife and a sponge.
2. Remove the residues with a vacuum cleaner (fig. 32).

### **Cleaning the infuser**

The infuser must be cleaned at least once a month.

#### **Important!**

The infuser (A11) must not be removed when the appliance is on.

Do not attempt to use force to remove the infuser as this could damage the coffee maker.

1. Make sure the machine is correctly turned off (see "Turning the appliance off").
2. Open the service door (fig. 27).
3. Remove the drip tray and grounds container (fig. 28).
4. Press the two red release buttons inwards and at the same time pull the infuser outwards (fig. 33).

#### **Important!**

Do not use washing up liquid to clean the infuser. It would remove the lubricant applied to the inside of the piston, causing the infuser to seize up and become unusable.

5. Soak the infuser in water for about 5 minutes, then rinse under the tap.
6. After cleaning, replace the infuser by sliding

it onto the internal support and pin at the bottom, then push the PUSH symbol fully in until it clicks into place.

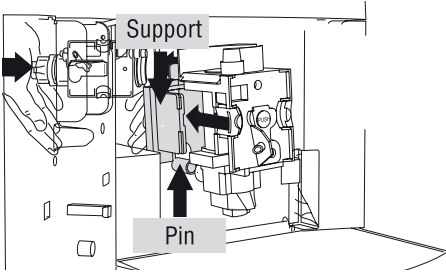

**i Please note:**

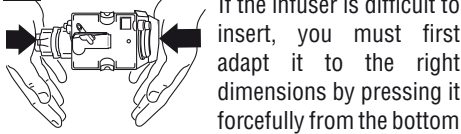

If the infuser is difficult to insert, you must first adapt it to the right dimensions by pressing it forcefully from the bottom

and top as shown in the figure.

7. Once inserted, make sure the two red buttons have snapped out.
8. Replace the drip tray and grounds container.
9. Close the service door.

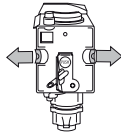

**Cleaning the milk container**

Clean the milk container regularly as described below:

1. Turn the milk container lid clockwise then remove it.
2. Remove the milk spout and intake tube.
3. Remove the froth regulator by pulling it outwards.
4. Wash all the components thoroughly with hot water and mild washing-up liquid.

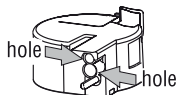
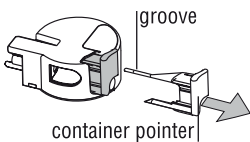
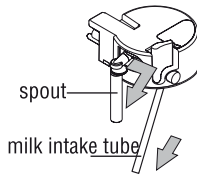

All components can be washed in a dishwasher, placing them in the top basket of

the dishwasher.

Make sure there are no milk residues left inside the holes and the groove on the fine end of the froth regulator.

5. Check that the intake tube and spout are not clogged with milk residues.
6. Replace the froth regulator, milk spout and intake tube.
7. Replace the lid on the milk container, turning it anticlockwise to hook it in place.

**DESCALE**

Descal the machine when the message “DESCALE!” flashes on the display.

**! Important!**

Descaler contains acids which may irritate the skin and eyes.

It is vital to respect the manufacturer’s safety warnings given on the descaler pack and the warnings relating to the procedure to follow in the event of contact with the skin and eyes.

**i Please note:**

Use De’Longhi descaler only. Under no circumstances should you use sulphamic or acetic based descalers. Their use invalidates the guarantee. Failure to descale the appliance as described also invalidates the guarantee.

1. Turn the machine on.
2. Enter the settings menu by pressing the **P** button.
3. Press the button (corresponding to the > symbol flashing on the display) until the menu arrow is on “DESCALE NO”.
4. Press the button (corresponding to the **SET** symbol flashing on the display) and “DESCALE YES” appears. Press **OK** to activate the function.
5. The message “ADD DESCALER” is displayed.
6. Before confirming, empty the water tank (A12).  
Pour the descaler diluted with water (respecting the proportions indicated on the descaler bottle) into the water tank.  
Place an empty container with a minimum capacity of 1.5 litres under the hot water spout.



### **Important! Danger of burns**

Hot water containing acid flows out of the hot water spout.

Avoid contact with splashes of water.

7. Confirm with the **OK** button.
8. The message “DESCALING IN PROGRESS” is displayed. The descaling programme starts and the descaler liquid comes out of the water spout. The descale programme automatically performs a series of rinses and pauses to remove limescale deposits from inside the machine.

After about 30 minutes, the message “RINSING... FILL TANK!” is displayed.

9. The appliance is now ready for rinsing through with clean water.

Remove the water tank, empty, rinse under running water, fill with clean water and replace. “RINSING... PRESS OK” is displayed.

10. Empty the container used to collect the descaler solution and replace it under the hot water spout.
11. Press the **OK** button to start rinsing. Hot water flows out of the spout and the message “RINSING...” is displayed.
12. When the water tank is completely empty, the message “RINSING COMPLETE... PRESS OK” is displayed.
13. Press the **OK** button, fill the water tank and the appliance is ready for use.

## **SETTING WATER HARDNESS**

The DESCALE message is displayed after a period of time established according to water hardness.

The machine is factory set for a hardness value of 4. The machine can also be programmed according to the hardness of the mains water in the various regions, varying the frequency with which the message is displayed.

### **Measuring water hardness**

1. Remove the “TOTAL HARDNESS TEST” indicator paper from its pack.
2. Immerse the paper completely in a glass of water for one second.
3. After about a minute, 1, 2, 3, or 4 red squares

form, depending on the hardness of the water. Each square corresponds to one level.

Level 1

Level 2

Level 3

Level 4

### **Set water hardness**

1. Press the **P** button to enter the menu.
2. Press the button (corresponding to the symbol flashing on the display) repeatedly until the menu arrow is on “WATER HARDNESS”.
3. Press the button (corresponding to the **SET** symbol flashing on the display) until the number displayed coincides with the number of red squares on the test strip.
4. Press the **OK** button to confirm the setting.
5. Press the **P** button (corresponding to the **ESC** symbol flashing on the display) to exit programming mode or to change other parameters.

The machine is now reprogrammed with the new water hardness setting.

## **SETTING THE LANGUAGE**

To change the language on the display, proceed as follows:

- Press the **OK** button for at least 5 seconds until the appliance displays the installation message in various languages.
- When the language required appears, press **OK** for 3 seconds.

## **TECHNICAL SPECIFICATION**

Voltage:	120 V~ 60 Hz max. 10A
Absorbed power:	1350W
Pressure:	15 bars
Water tank capacity:	1,8 litres
Size LxHxD:	282x374x441 mm
Weight:	11,4 Kg

## DISPLAYED MESSAGES

MESSAGE	MEANING	WHAT TO DO
FILL TANK	<ul style="list-style-type: none"> <li>The water tank is empty or positioned incorrectly.</li> </ul>	<ul style="list-style-type: none"> <li>Fill the tank with water and/or insert it correctly, pushing it as far as it will go.</li> </ul>
GROUND TOO FINE ADJUST GRINDER AND INSERT WATER SPOUT AND PRESS OK	<ul style="list-style-type: none"> <li>The grinding is too fine and the coffee is delivered too slowly.</li> </ul>	<ul style="list-style-type: none"> <li>Repeat coffee delivery and turn the grinding adjustment knob one click clockwise towards "7" while the coffee grinder is in operation. The effect is only visible after delivering two coffees.</li> </ul>
	<ul style="list-style-type: none"> <li>The machine cannot make coffee as there is air in the hydraulic circuit.</li> </ul>	<ul style="list-style-type: none"> <li>Press the OK button to deliver water from the spout until it flows out normally.</li> </ul>
EMPTY GROUNDS CONTAINER	<ul style="list-style-type: none"> <li>The grounds container is full or more than three days have passed since you last made coffee (this guarantees correct hygiene of the machine).</li> </ul>	<ul style="list-style-type: none"> <li>Empty the grounds container and clean, then replace. Important: when removing the drip tray, the grounds container <b>MUST</b> be emptied, even if it is not completely full. If this is not done, when you make the next coffees, the grounds container may fill up more than expected and clog the machine.</li> </ul>
INSERT GROUNDS CONTAINER	<ul style="list-style-type: none"> <li>After cleaning, the grounds container has not been replaced.</li> </ul>	<ul style="list-style-type: none"> <li>Open the service door and insert the grounds container.</li> </ul>
ADD PRE-GROUND COFFEE	<ul style="list-style-type: none"> <li>With the function selected, pre-ground coffee has not been poured into the funnel.</li> </ul>	<ul style="list-style-type: none"> <li>Place pre-ground coffee in the funnel.</li> </ul>
	<ul style="list-style-type: none"> <li>The funnel (A8) is blocked.</li> </ul>	<ul style="list-style-type: none"> <li>Empty the funnel with the help of a knife, as described in the section "Cleaning the pre-ground coffee funnel".</li> </ul>
FILL BEANS CONTAINER	<ul style="list-style-type: none"> <li>The coffee beans have run out.</li> </ul>	<ul style="list-style-type: none"> <li>Fill beans container</li> </ul>
	<ul style="list-style-type: none"> <li>The pre-ground coffee funnel is clogged.</li> </ul>	<ul style="list-style-type: none"> <li>Empty the funnel with the help of a knife, as described in the section "Cleaning the pre-ground coffee funnel".</li> </ul>
DESCALE	<ul style="list-style-type: none"> <li>The machine must be descaled.</li> </ul>	<ul style="list-style-type: none"> <li>The descaling procedure described in the "Descale" section needs to be performed as soon as possible.</li> </ul>
CLOSE DOOR	<ul style="list-style-type: none"> <li>The service door is open</li> </ul>	<ul style="list-style-type: none"> <li>Close the service door.</li> </ul>
INSERT WATER SPOUT	<ul style="list-style-type: none"> <li>The hot water spout is not inserted or is inserted incorrectly.</li> </ul>	<ul style="list-style-type: none"> <li>Insert the hot water spout as far as it will go.</li> </ul>
INSERT INFUSER ASSEMBLY	<ul style="list-style-type: none"> <li>The infuser has not been replaced after cleaning.</li> </ul>	<ul style="list-style-type: none"> <li>Insert the infuser as described in the section "Cleaning the infuser".</li> </ul>
REDUCE COFFEE AMOUNT	<ul style="list-style-type: none"> <li>Too much coffee has been used.</li> </ul>	<ul style="list-style-type: none"> <li>Select a milder taste or reduce the quantity of pre-ground coffee, then make the coffee again.</li> </ul>
INSERT MILK CONTAINER!	<ul style="list-style-type: none"> <li>The milk container is not inserted.</li> </ul>	<ul style="list-style-type: none"> <li>Insert the milk container as far as it will go.</li> </ul>

MESSAGE	MEANING	WHAT TO DO
GENERAL ALARM	<ul style="list-style-type: none"> <li>The inside of the appliance is very dirty..</li> </ul>	<ul style="list-style-type: none"> <li>Clean the appliance thoroughly as described in the section “Cleaning the inside of the coffee maker”. If the message is still displayed after cleaning, contact Customer Services.</li> </ul>
PRESS CLEAN BUTTON	<ul style="list-style-type: none"> <li>Milk has been delivered recently and the tubes inside the milk container must be cleaned.</li> </ul>	<ul style="list-style-type: none"> <li>Press the CLEAN button and hold it down for at least 8 seconds. The message “CLEANING” is displayed.</li> </ul>

## TROUBLESHOOTING

Below is a list of some of the possible malfunctions.

If the problem cannot be resolved as described, contact Customer Services.

PROBLEM	POSSIBLE CAUSE	REMEDY
The coffee is not hot	<ul style="list-style-type: none"> <li>The cups were not preheated.</li> </ul>	<ul style="list-style-type: none"> <li>Warm the cups by rinsing them with hot water.</li> </ul>
	<ul style="list-style-type: none"> <li>The infuser has cooled down because 2/3 minutes have elapsed since the last coffee was made.</li> </ul>	<ul style="list-style-type: none"> <li>Before making coffee, rinse as described in the notes in the section “Making coffee using coffee beans”.</li> </ul>
The coffee is not creamy enough	<ul style="list-style-type: none"> <li>The coffee is ground too coarsely.</li> </ul>	<ul style="list-style-type: none"> <li>Turn the grinding adjustment knob one click anticlockwise towards “1” while the coffee grinder is in operation (fig. 7). Continue one click at a time until coffee delivery is satisfactory.</li> </ul>
	<ul style="list-style-type: none"> <li>Wrong type of coffee</li> </ul>	<ul style="list-style-type: none"> <li>Use a type of coffee for espresso coffee makers.</li> </ul>
The coffee is delivered too slowly or a drop at a time.	<ul style="list-style-type: none"> <li>The coffee is ground too finely.</li> </ul>	<ul style="list-style-type: none"> <li>Turn the grinding adjustment knob one click clockwise towards “7” while the coffee grinder is in operation (fig. 7). Continue one click at a time until coffee delivery is satisfactory. The effect is only visible after delivering two coffees.</li> </ul>
The coffee is delivered too quickly.	<ul style="list-style-type: none"> <li>The coffee is ground too coarsely.</li> </ul>	<ul style="list-style-type: none"> <li>Turn the grinding adjustment knob one click anticlockwise towards “1” while the coffee grinder is in operation (fig. 7). Avoid turning the grinding adjustment knob excessively otherwise when you select 2 cups, the coffee may be delivered a drop at a time. The effect is only visible after delivering two coffees.</li> </ul>
Coffee does not come out of one of the spouts.	<ul style="list-style-type: none"> <li>The spouts are blocked.</li> </ul>	<ul style="list-style-type: none"> <li>Clean the spouts with a toothpick.</li> </ul>
	<ul style="list-style-type: none"> <li>The coffee guide inside the service door is blocked and cannot swing.</li> </ul>	<ul style="list-style-type: none"> <li>Thoroughly clean the coffee guide, particularly near the hinges.</li> </ul>
Water comes out of the spouts instead of coffee.	<ul style="list-style-type: none"> <li>The pre-ground coffee may be blocked in the funnel. (A8).</li> </ul>	<ul style="list-style-type: none"> <li>Empty the funnel with the help of a knife, as described in the section “Cleaning the pre-ground coffee funnel”.</li> </ul>

<b>PROBLEM</b>	<b>POSSIBLE CAUSE</b>	<b>REMEDY</b>
The milk does not come out of the milk spout. (B5).	<ul style="list-style-type: none"> <li>The intake tube is not inserted or is inserted incorrectly.</li> </ul>	<ul style="list-style-type: none"> <li>Insert the intake tube in the rubber washer in the milk container lid (fig. 16).</li> </ul>
The milk is not well frothed.	<ul style="list-style-type: none"> <li>The froth regulator is incorrectly adjusted.</li> </ul>	<ul style="list-style-type: none"> <li>Adjust following the instructions in the section on preparing drinks with milk.</li> </ul>
	<ul style="list-style-type: none"> <li>The milk container lid is dirty.</li> </ul>	<ul style="list-style-type: none"> <li>Clean the milk container lid as described in the section "Cleaning the milk container".</li> </ul>
The milk contains bubbles or squirts out of the milk spout.	<ul style="list-style-type: none"> <li>The milk is not cold enough or is not semi-skimmed.</li> </ul>	<ul style="list-style-type: none"> <li>You should ideally use skimmed or semi-skimmed milk at refrigerator temperature (about 5°C). If the result is still disappointing, try another brand of milk.</li> </ul>
	<ul style="list-style-type: none"> <li>The froth regulator is incorrectly adjusted.</li> </ul>	<ul style="list-style-type: none"> <li>Adjust following the instructions in the section on preparing drinks with milk.</li> </ul>
	<ul style="list-style-type: none"> <li>The milk container lid is dirty.</li> </ul>	<ul style="list-style-type: none"> <li>Clean the milk container lid as described in the section "Cleaning the milk container".</li> </ul>
The appliance does not come on.	<ul style="list-style-type: none"> <li>It is not plugged into the mains socket.</li> </ul>	<ul style="list-style-type: none"> <li>Plug into the mains socket.</li> </ul>
	<ul style="list-style-type: none"> <li>The main switch is not turned on.</li> </ul>	<ul style="list-style-type: none"> <li>Place the main switch on the back of the appliance in the I position (fig. 1).</li> </ul>
"Energy Saving" mode is enabled, but the cup warmer is hot	<ul style="list-style-type: none"> <li>A number of drinks have been prepared in rapid succession.</li> </ul>	



## LIMITED WARRANTY

---

This warranty applies to all products with De'Longhi or Kenwood brand names.

### **What does the warranty cover?**

We warrant each appliance to be free from defects in material and workmanship. Our obligation under this warranty is limited to repair at our factory or authorized service center of any defective parts or part thereof, other than parts damaged in transit. In the event of a products replacement or return, the unit must be returned transportation prepaid. The repaired or new model will be returned at the company expense.

This warranty shall apply only if the appliance is used in accordance with the factory directions, which accompany it, and on an Alternating current ( AC ) circuit.

### **How long does the coverage last?**

This warranty runs for two years (2) from the purchase date found on your receipt and applies only to the original purchaser for use.

### **What is not covered by the warranty?**

The warranty does not cover defects or damage of the appliance, which result from repairs or alterations to the appliance outside our factory or authorized service centers, nor shall it apply to any appliance, which has been subject to abuse, misuse, negligence or accidents. Also, consequential and incidental damage resulting from the use of this product or arising out of any breach of contract or breach of this warranty are not recoverable under this warranty. Some states do not allow the exclusion or limitation of incidental or consequential damage, so the above limitation may not apply to you.

### **How do you get service?**

If repairs become necessary, see contact information below:

**U.S. Residents:** Please contact our toll free hotline at 1-866-528-8323 (1-866-Latte-Best) or log onto our website at [www.delonghi.com](http://www.delonghi.com)

**Residents of Canada:** Please contact our toll free hotline at 1-888-335-6644 or log onto our website at [www.delonghi.com](http://www.delonghi.com)

**Residents of Mexico:** Please contact our toll free number 01-800-711-8805 for assistance or log onto our website at [www.delonghi.com](http://www.delonghi.com)

The above warranty is in lieu of all other express warranties and representations. All implied warranties are limited to the applicable warranty period set forth above. This limitation does not apply if you enter into an extended warranty with De'Longhi. Some states/countries do not allow limitations on how long an implied warranty lasts, so the above exclusions may not apply to you. De'Longhi does not authorize any other person or company to assume for it any liability in connection with the sale or use of its appliance.

### **How does country law apply?**

This warranty gives you specific legal rights, and you may also have other rights, which vary from state to state/country to country.